

ARTICLE.

VERSION 1.0

Assembly Instructions

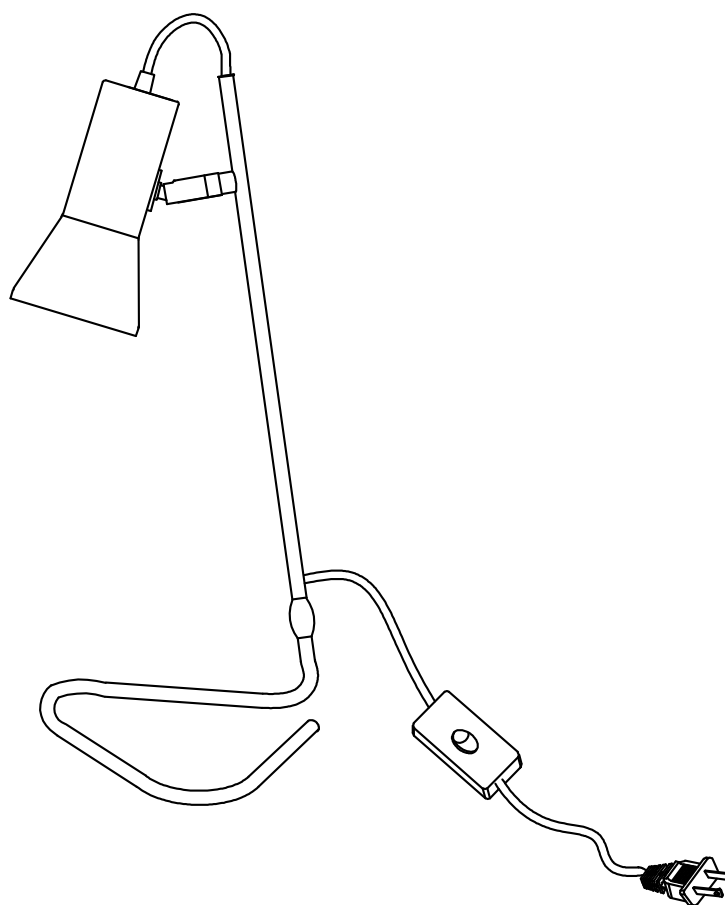

TORCH

Table Lamp

ASSEMBLY INSTRUCTIONS

Read these instructions carefully and keep for future reference. Refer to parts inventory for guidance, and ensure you have all pieces before starting.

When assembling, place all parts on a soft, clean, and flat surface such as a carpet to prevent scratches.

If you're having difficulty, our friendly Customer Care team is always here to help. Call us at **1.888.746.3455** during business hours, email service@article.com or chat live at article.com.

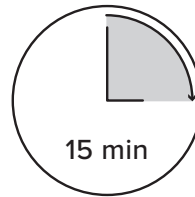

TIME

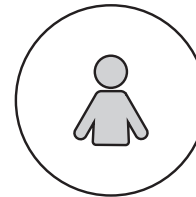

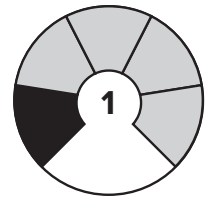

OF PEOPLE

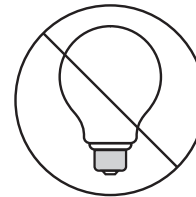

DIFFICULTY



BULB NOT INCLUDED
E12 / MAX 25W

PARTS INVENTORY		
ID	DESCRIPTION	QTY
A	LAMP STAND	1
B	BASE	1
C	SMALL BOLT 	2
D	ALLEN KEY 	1

1

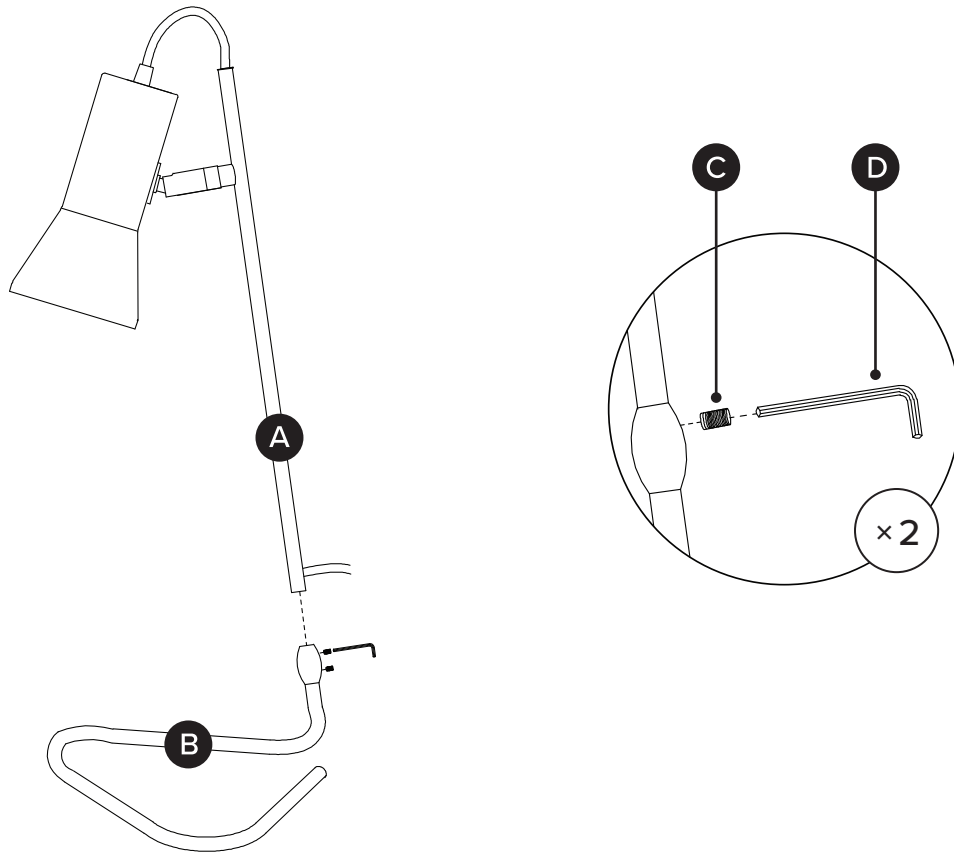

2

