

ARTICLE.

VERSION 1.0

Assembly Instructions

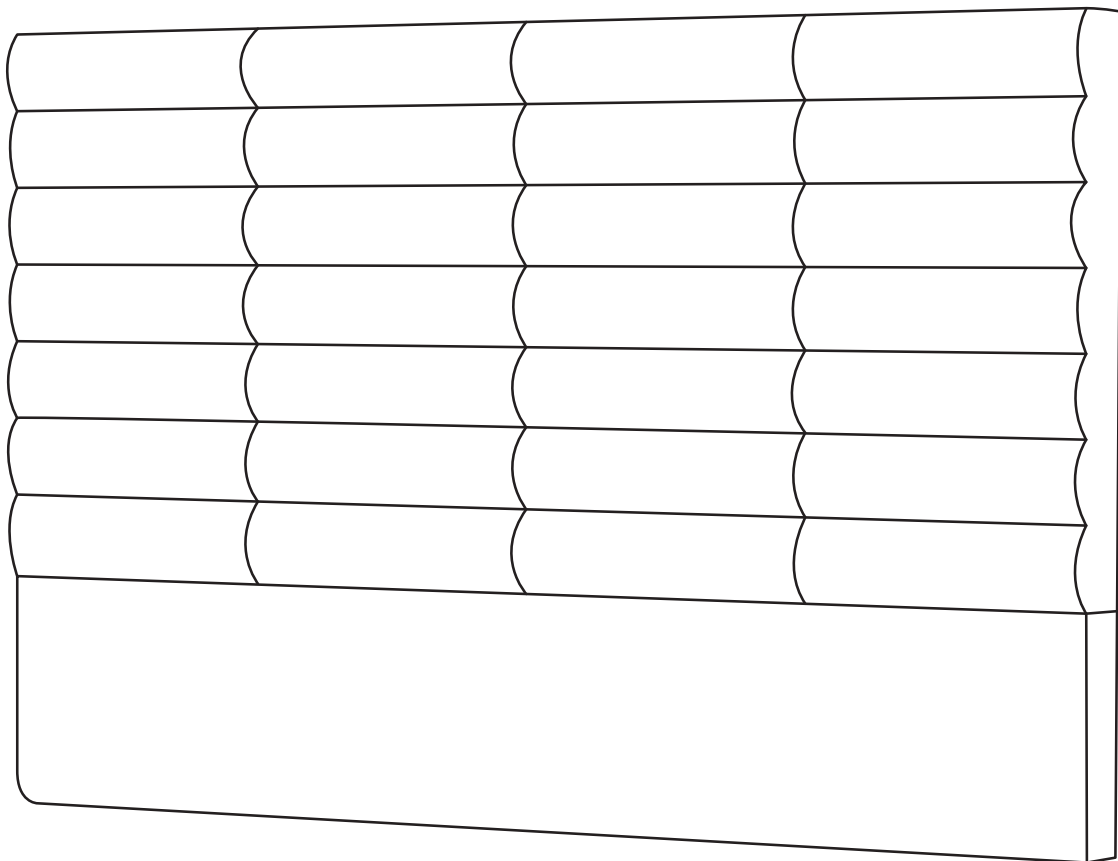

SERA

Headboard

ASSEMBLY INSTRUCTIONS

Read these instructions carefully and keep for future reference. Refer to parts inventory for guidance, and ensure you have all pieces before starting.

When assembling, place all parts on a soft, clean, and flat surface such as a carpet to prevent scratches.

If you're having difficulty, our friendly Customer Care team is always here to help. Call us at **1.888.746.3455** during business hours, email service@article.com or chat live at [article.com](https://www.article.com).

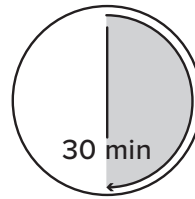

TIME



OF PEOPLE

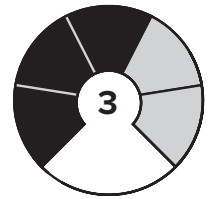

DIFFICULTY

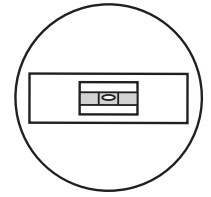
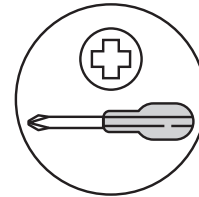
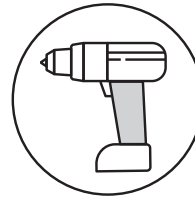

REQUIRED TOOLS

PARTS INVENTORY		
ID	DESCRIPTION	QTY
A	CLEAT	1
B	45MM SCREW 	4



Screws (B) to attach cleat (A) to wall are designed for wood studs. To attach this headboard to another type of wall, consult with your local hardware store.

1

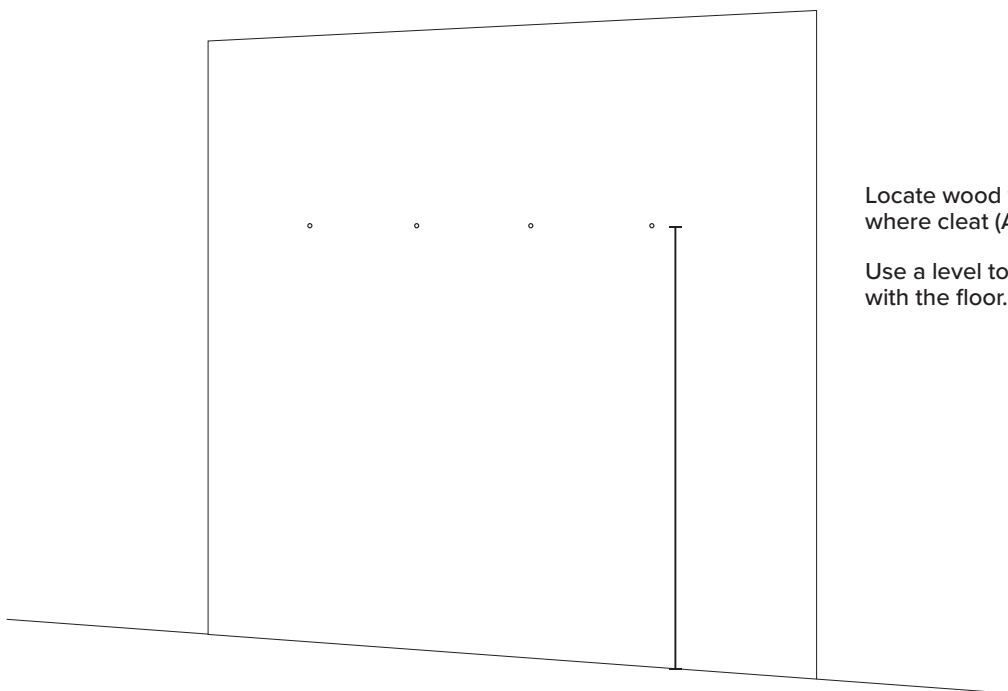

Locate wood wall studs and mark on wall where cleat (A) should be mounted.

Use a level to ensure that the cleat is level with the floor. Drill holes into wood wall studs.



Headboard should be resting on the floor.

2

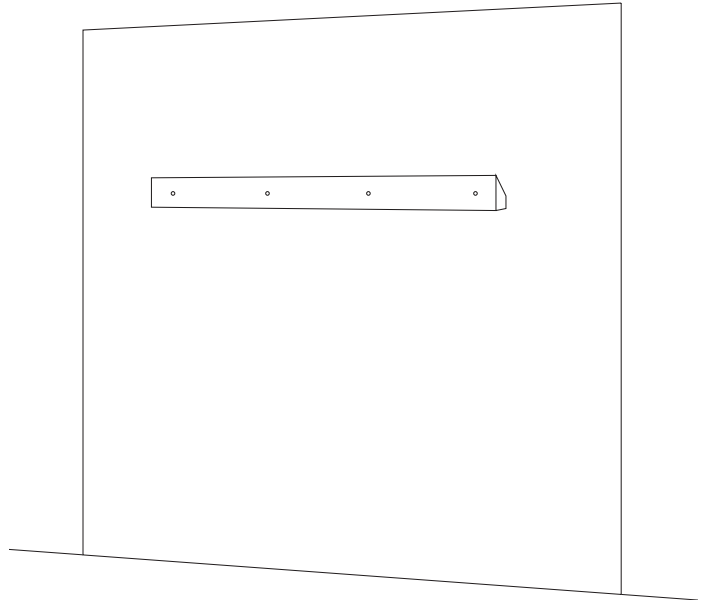
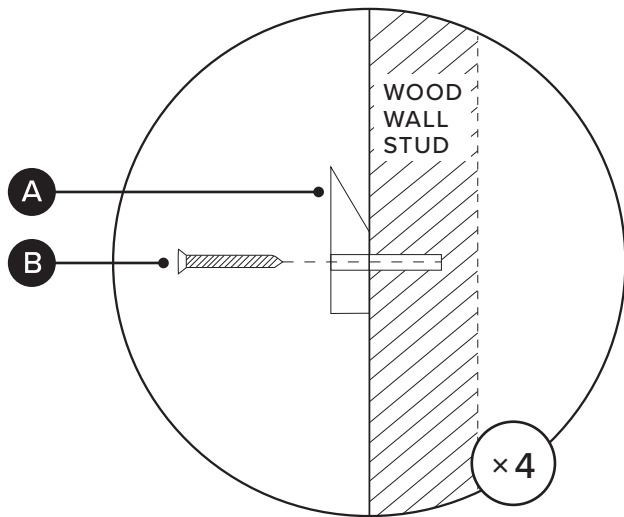

3

