

# ARTICLE.

VERSION 1.0

## Assembly Instructions

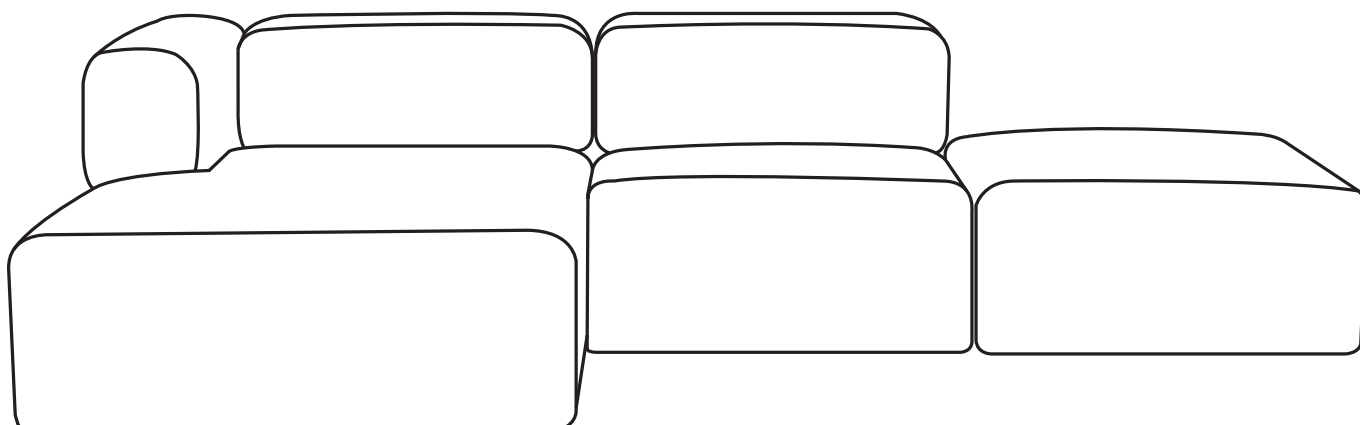

# QUADRA

Modular Sofa

## ASSEMBLY INSTRUCTIONS

Read these instructions carefully and keep for future reference. Refer to parts inventory for guidance, and ensure you have all pieces before starting.

When assembling, place all parts on a soft, clean, and flat surface such as a carpet to prevent scratches.

If you're having difficulty, our friendly Customer Care team is always here to help. Call us at **1.888.746.3455** during business hours, email [service@article.com](mailto:service@article.com) or chat live at [article.com](https://www.article.com).

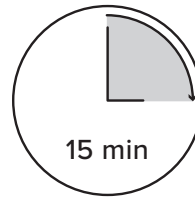

15 min

TIME

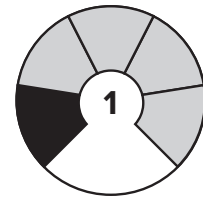

1

DIFFICULTY

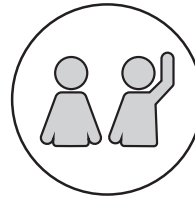

# OF PEOPLE

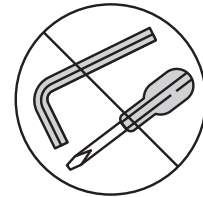

TOOL FREE

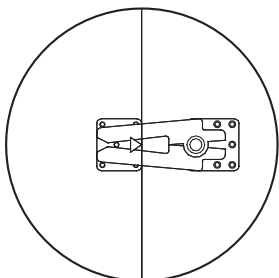
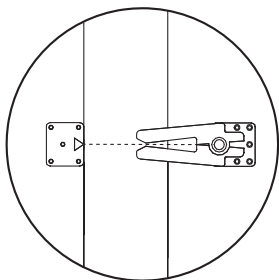

Align alligator clips and pegs, then push sofa modules together firmly.

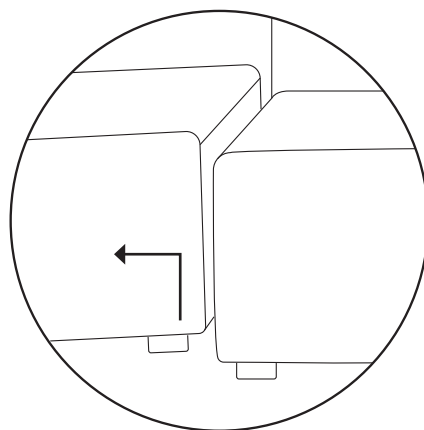

To separate sections, lift section with pegs straight up and out of the teeth of the clips.

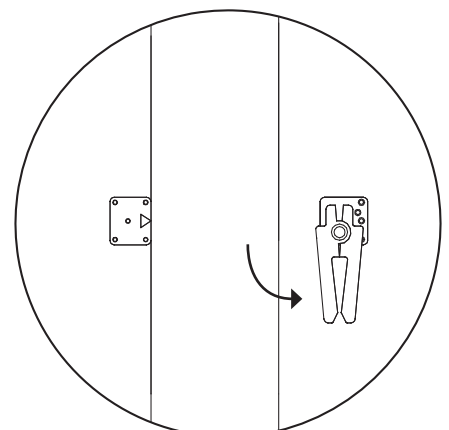

Rotate clips underneath furniture when not in use.

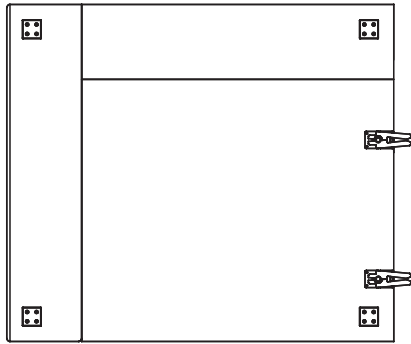

LEFT ARM MODULE

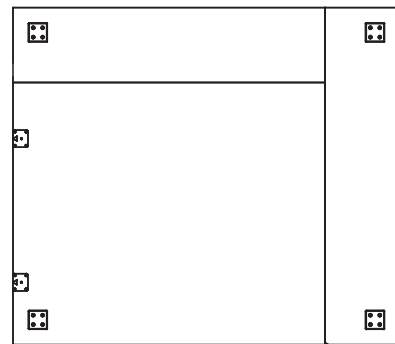

RIGHT ARM MODULE

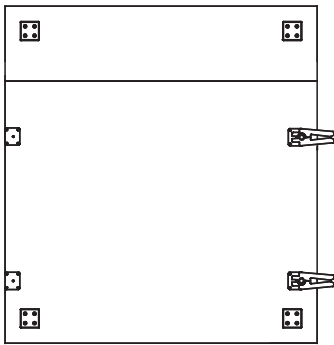

ARMLESS CHAIR MODULE

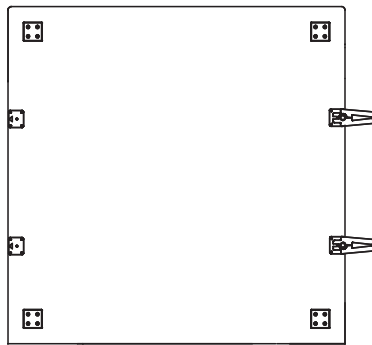

OTTOMAN

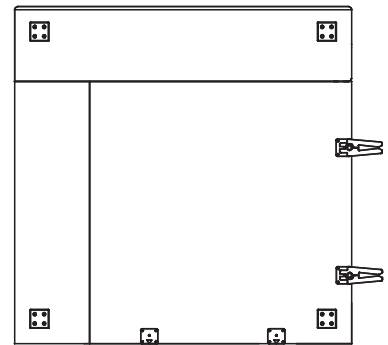

CORNER MODULE

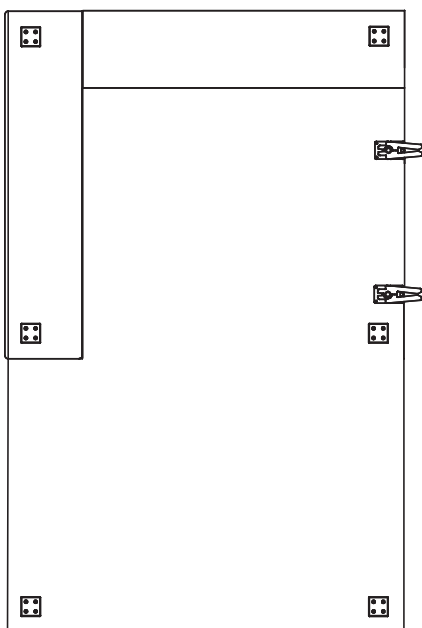

LEFT CHAISE MODULE

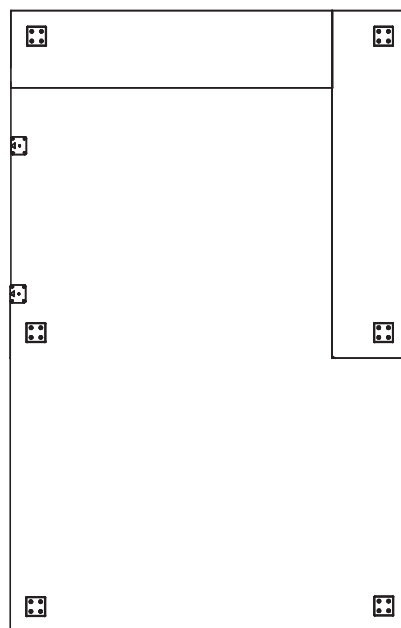

RIGHT CHAISE MODULE