

ARTICLE.

VERSION 1.0

Assembly Instructions

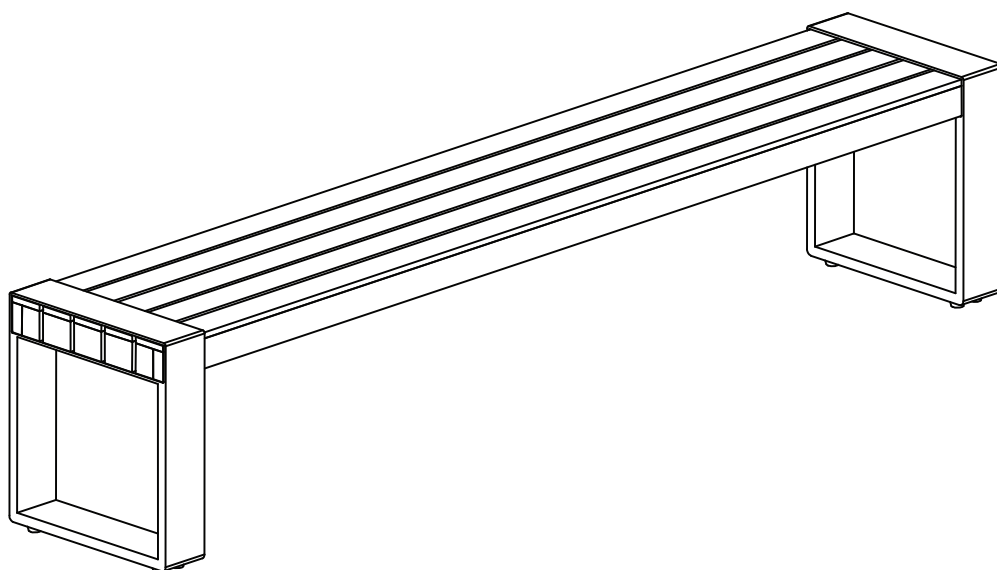

LUBEK

Bench

ASSEMBLY INSTRUCTIONS

Read these instructions carefully and keep for future reference. Refer to parts inventory for guidance, and ensure you have all pieces before starting.

When assembling, place all parts on a soft, clean, and flat surface such as a carpet to prevent scratches.

If you're having difficulty, our friendly Customer Care team is always here to help. Call us at **1.888.746.3455** during business hours, email service@article.com or chat live at article.com.

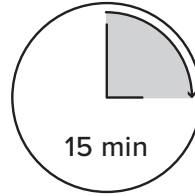

15 min

TIME





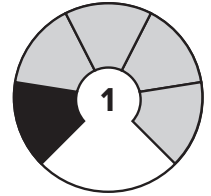

OF PEOPLE



DIFFICULTY



Hardware may loosen over time, check the bolts regularly and tighten if necessary.

PARTS INVENTORY		
ID	DESCRIPTION	QTY
A	LEG FRAME	2
B	ALLEN KEY 	1
C	M8 × 40MM BOLT 	8
D	LOCK WASHER 	8
E	WASHER 	8

1

