

ARTICLE.

VERSION 1.1

Assembly Instructions

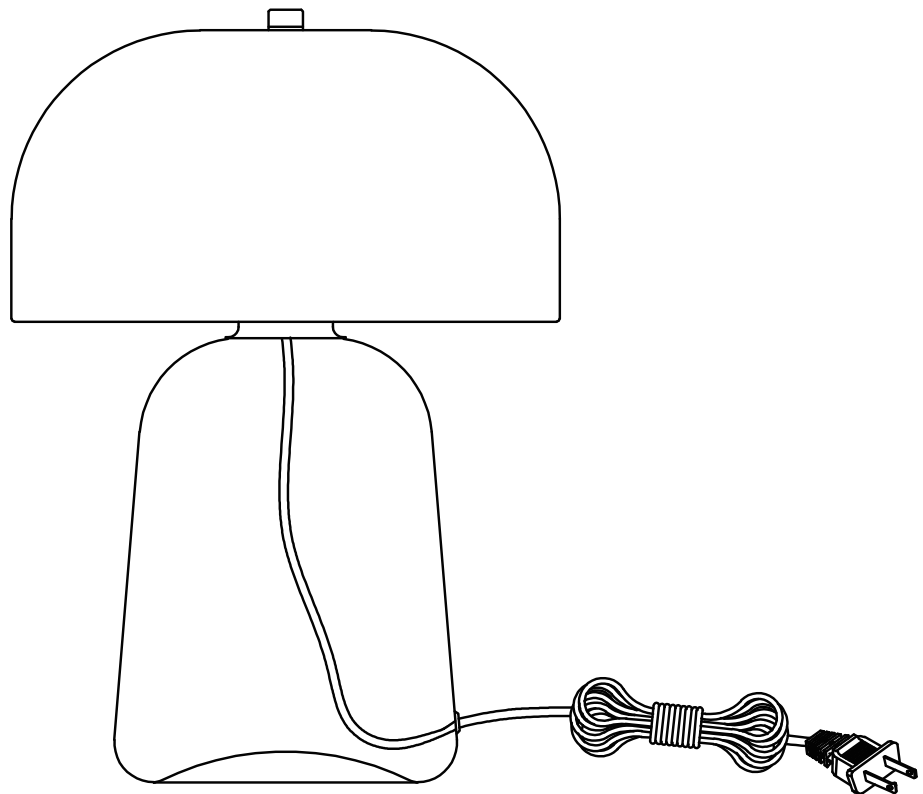

KOEPPEL

Table Lamp

ASSEMBLY INSTRUCTIONS

Read these instructions carefully and keep for future reference. Refer to parts inventory for guidance, and ensure you have all pieces before starting.

When assembling, place all parts on a soft, clean, and flat surface such as a carpet to prevent scratches.

If you're having difficulty, our friendly Customer Care team is always here to help. Call us at **1.888.746.3455** during business hours, email service@article.com or chat live at [article.com](https://www.article.com).

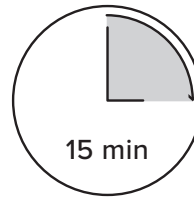

15 min

TIME

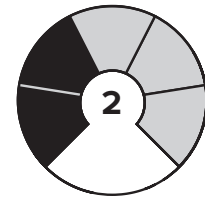

2

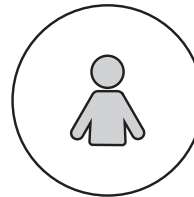

DIFFICULTY

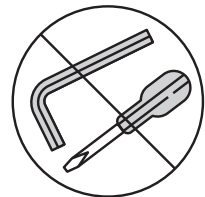

OF PEOPLE



TOOL FREE

| PARTS INVENTORY | | |
|-----------------|---|-----|
| ID | DESCRIPTION | QTY |
| A | BULB (E26 4W LED G45) | 1 |
| B | GLASS BASE | 1 |
| C | HARP FRAME | 1 |
| D | FINIAL  | 1 |
| E | M10 × 18MM WASHER  | 1 |
| F | METAL SHADE | 1 |
| G | M10 × 20MM WASHER  | 1 |

1

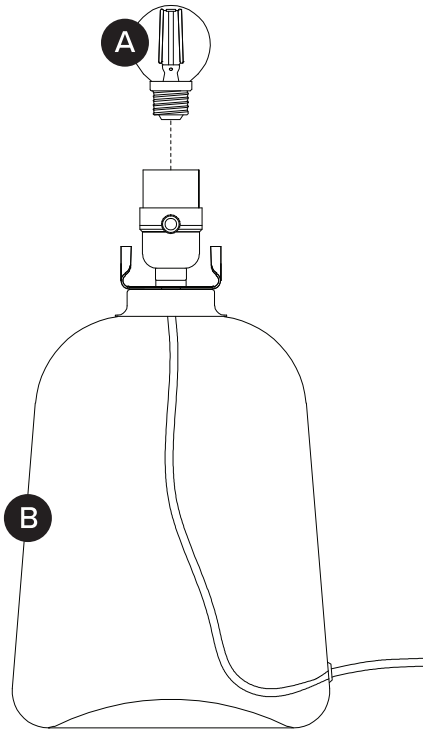

2

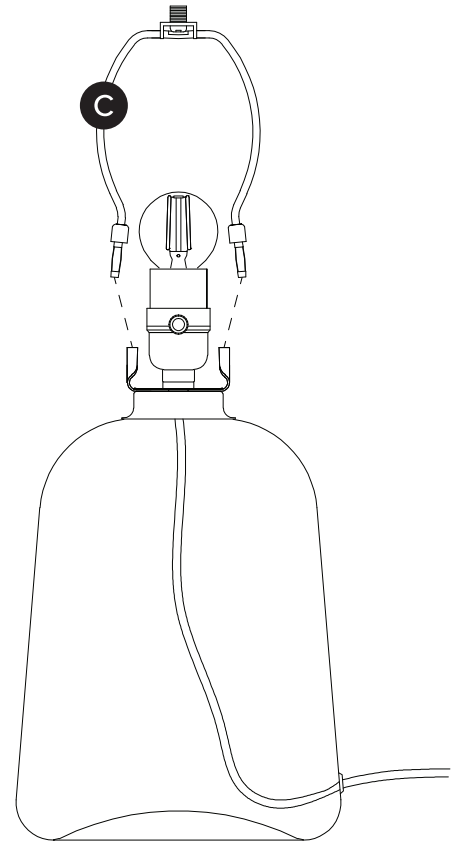

3

