

ARTICLE.

VERSION 1.0

Assembly Instructions

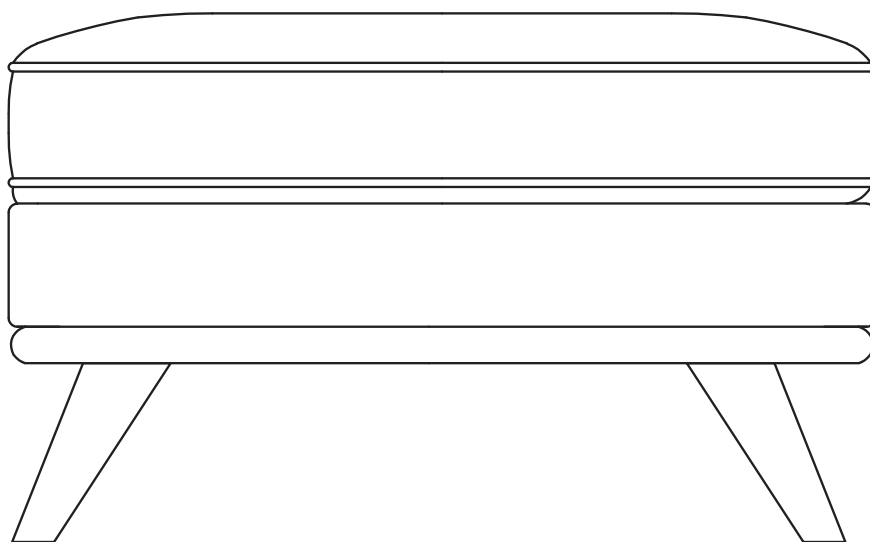

TIMBER

Ottoman

ASSEMBLY INSTRUCTIONS

Read these instructions carefully and keep for future reference. Refer to parts inventory for guidance, and ensure you have all pieces before starting.

When assembling, place all parts on a soft, clean, and flat surface such as a carpet to prevent scratches.

If you're having difficulty, our friendly Customer Care team is always here to help. Call us at **1.888.746.3455** during business hours, email service@article.com or chat live at [article.com](https://www.article.com).

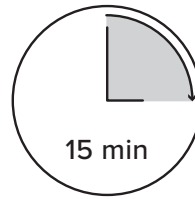

15 min

TIME





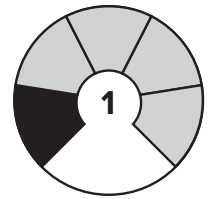

OF PEOPLE



DIFFICULTY

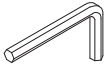

Hardware may loosen over time, check the bolts regularly and tighten if necessary.

PARTS INVENTORY		
ID	DESCRIPTION	QTY
A	LEGS	4
B	ALLEN KEY 	1
C	M10 × 60MM BOLT 	4
D	LOCK WASHER 	4
E	WASHER 	4

1

! Align dowels and insert legs (A) into ottoman first.

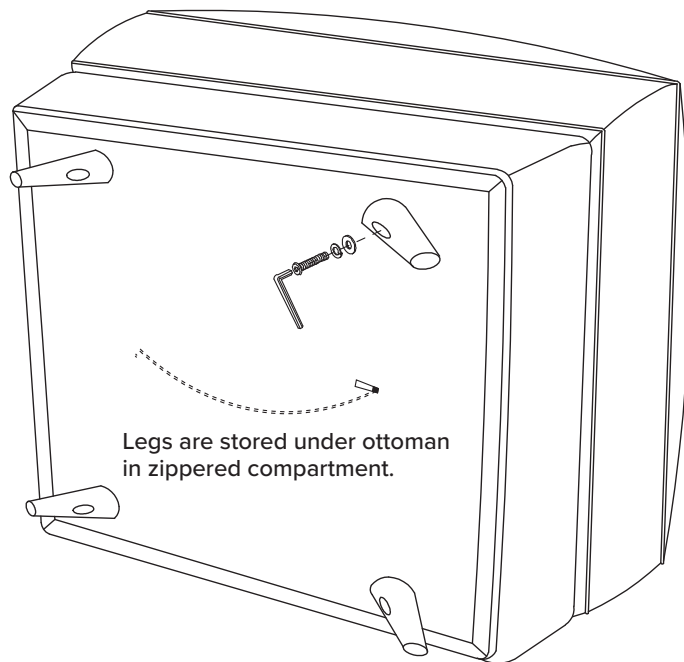
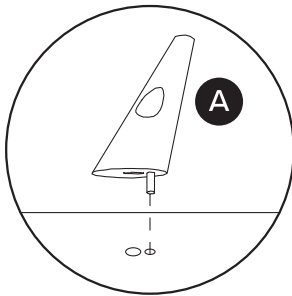

Legs are stored under ottoman in zippered compartment.

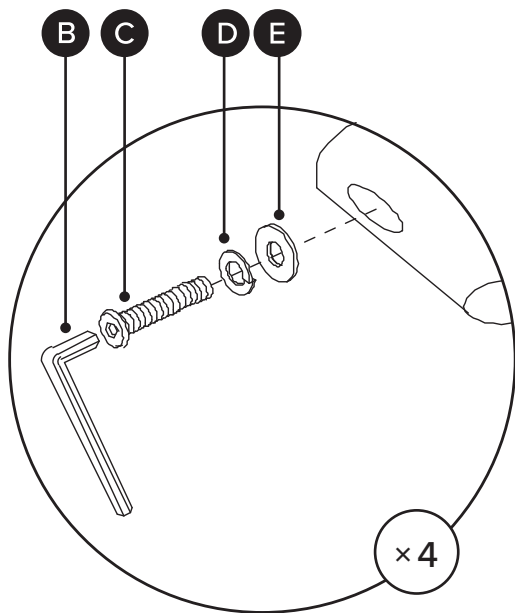

! Insert bolt (C) and washers (D/E) through hole on legs. Do not fully tighten right away.



! Check leg angles are all correct before fully tightening. Fully tightened bolts ensure leg stability when moving ottoman.