

# ARTICLE.

VERSION 1.0

## Assembly Instructions

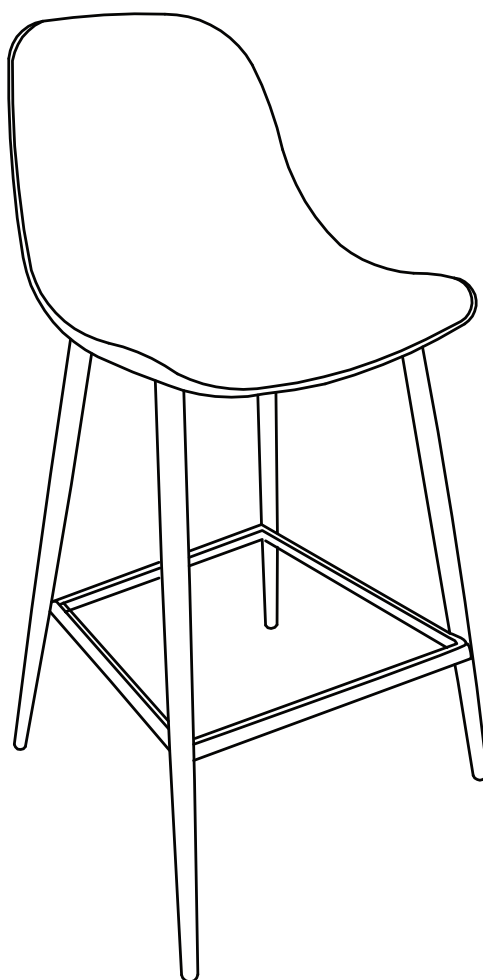

# SVELTI

Stool

## ASSEMBLY INSTRUCTIONS

Read these instructions carefully and keep for future reference. Refer to parts inventory for guidance, and ensure you have all pieces before starting.

When assembling, place all parts on a soft, clean, and flat surface such as a carpet to prevent scratches.

If you're having difficulty, our friendly Customer Care team is always here to help. Call us at **1.888.746.3455** during business hours, email [service@article.com](mailto:service@article.com) or chat live at [article.com](https://www.article.com).





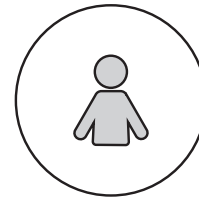

TIME / CHAIR

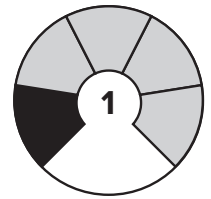

# OF PEOPLE

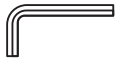

DIFFICULTY

PARTS INVENTORY		
ID	DESCRIPTION	QTY
<b>A</b>	LEG FRAME	1
<b>B</b>	ALLEN KEY 	1
<b>C</b>	BOLT 	4
<b>D</b>	LOCK WASHER 	4
<b>E</b>	WASHER 	4

1

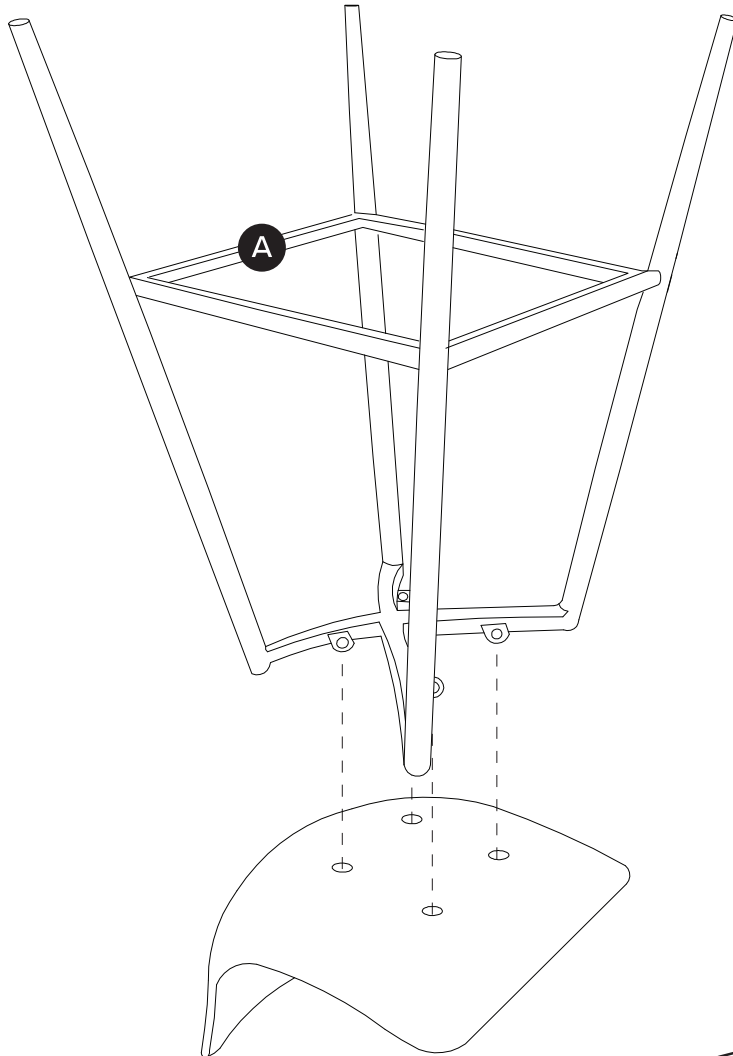

! Ensure bolts (C) and washers (D/E) are installed in the correct order to avoid damage to the stool.

