

ARTICLE.

VERSION 1.0

Assembly Instructions

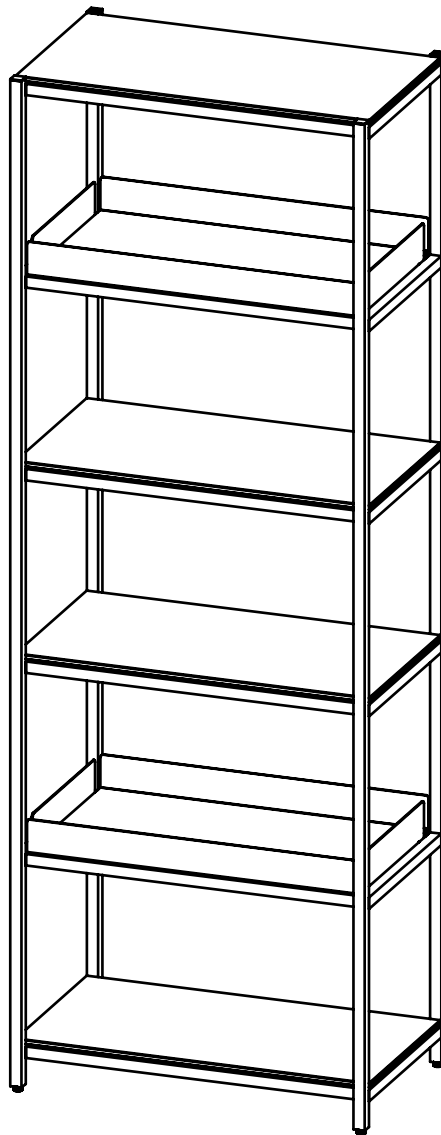

LUTTO

Bookcase



ANTI-TIP RESTRAINT INSTALLATION

WARNING!

Serious or fatal crushing injuries can occur from furniture tip-over. To help prevent tip-over:

- Install tip-over restraint provided.
- Do not set heavy objects on top of this product, unless the product is specifically designed to accommodate them.
- Never allow children to climb or hang on mirrors, shelves, consoles, or cabinets with doors and/or drawers.

Use of tip-over restraints may only reduce but not eliminate, the risk of tip-over.

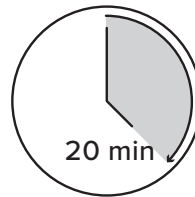

TIME

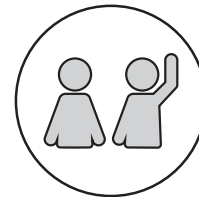

OF PEOPLE

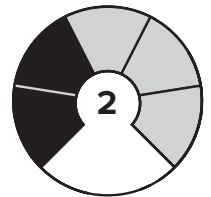

DIFFICULTY

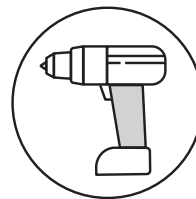



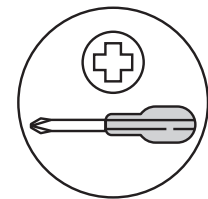



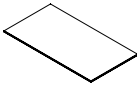
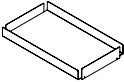

REQUIRED TOOL



REQUIRED TOOL

Hardware (I/J) to attach brackets to wall is designed for drywall. To attach this unit to another type of wall, consult with your local hardware store.

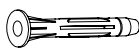
PARTS INVENTORY		
ID	DESCRIPTION	QTY
A	FRAME	1
B	SHELF 	4
C	TRAY 	2
D	FELT PAD 	36
E	4MM ALLEN KEY 	1

PARTS INVENTORY CONT.		
ID	DESCRIPTION	QTY
F	M6 × 15MM BOLT 	2
G	WASHER 	4
H	BRACKET 	2
I	PLUG 	2
J	SCREW 	2

1

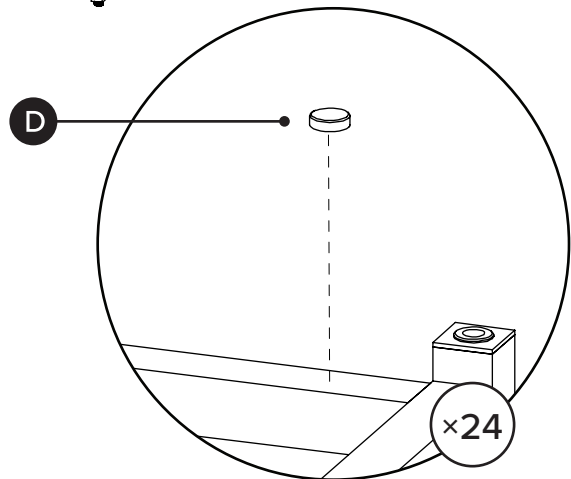
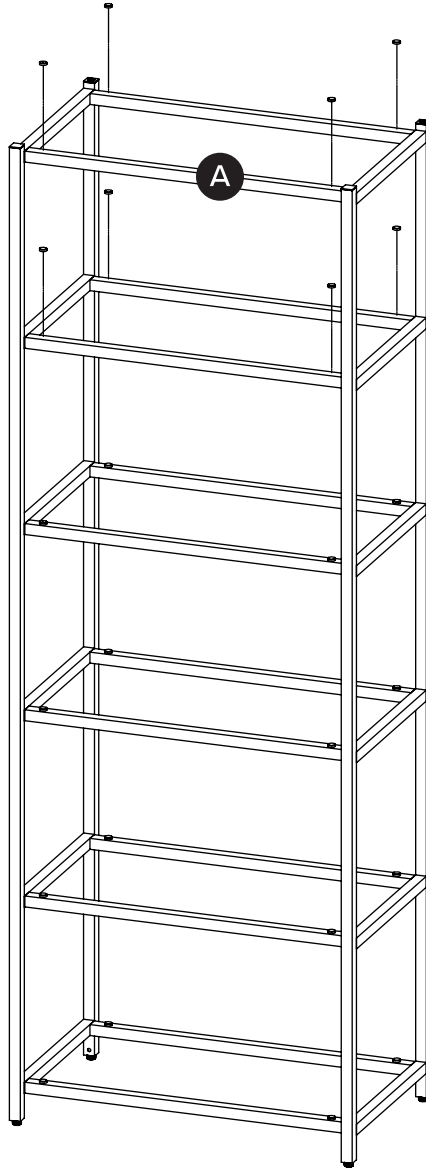

2

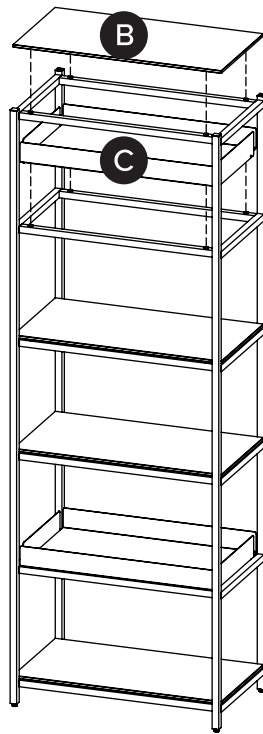

3

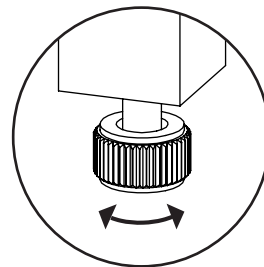
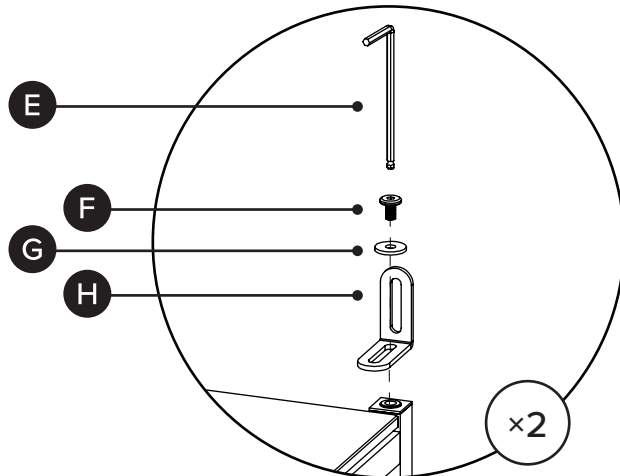
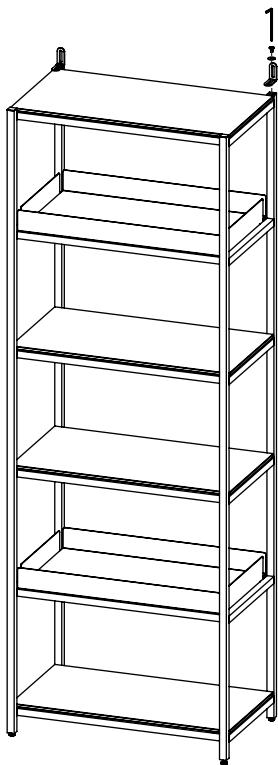

! Adjust levelers on legs as needed.

4

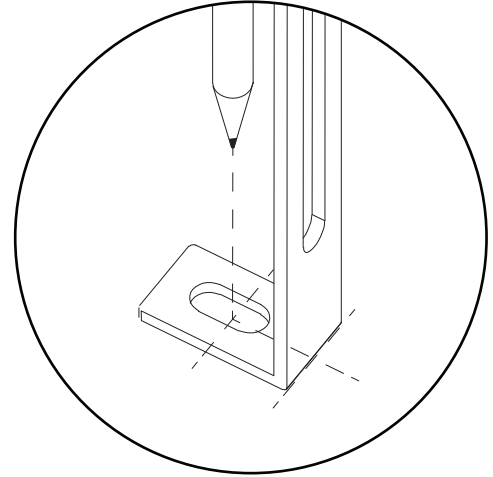
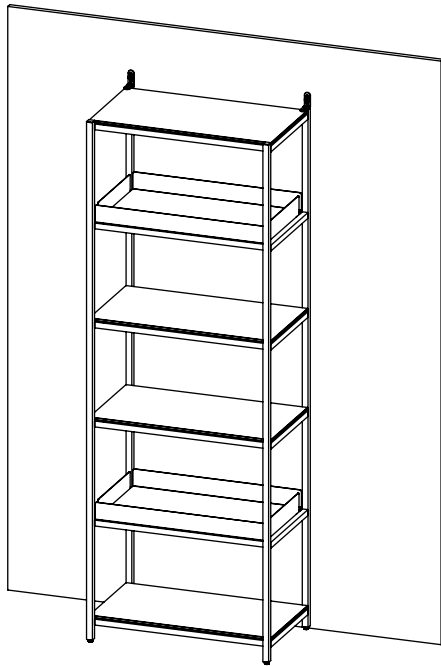

Place unit in desired location and mark on wall where holes should be drilled.

5

Drill holes into drywall, insert wall plugs (I) , and attach unit to wall.

