

ARTICLE.

VERSION 1.0

Assembly Instructions

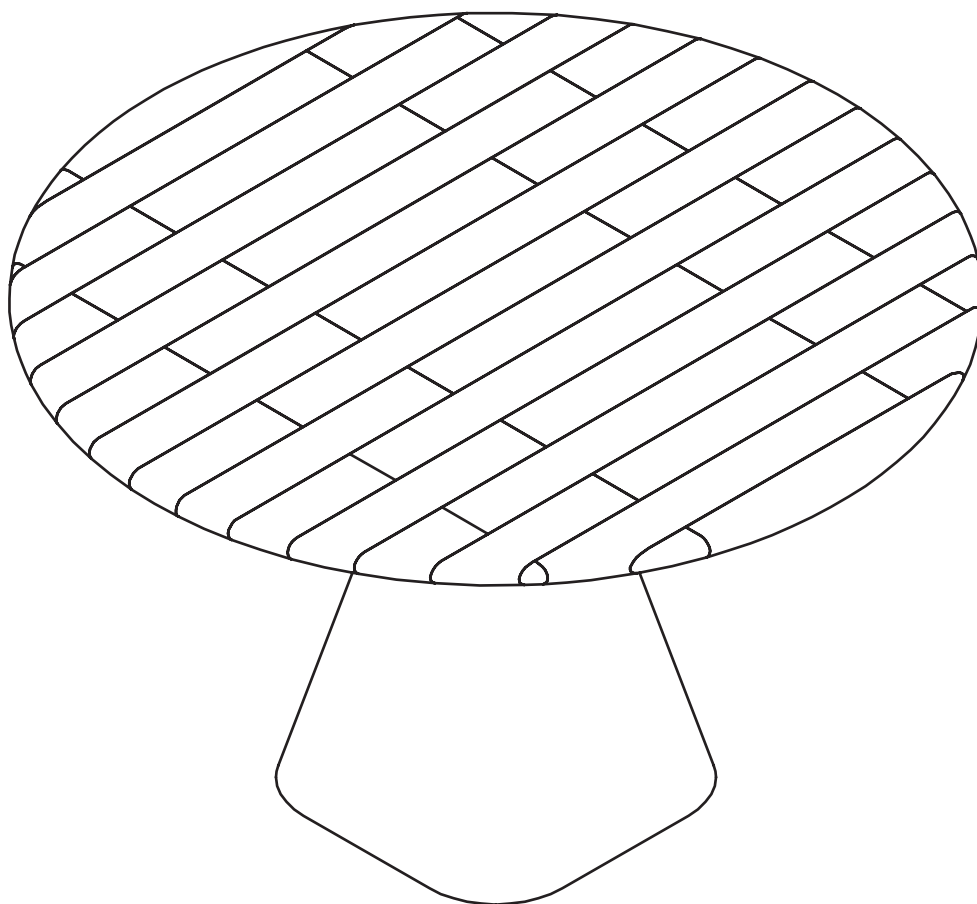

KURASI

Dining Table

ASSEMBLY INSTRUCTIONS

Read these instructions carefully and keep for future reference. Refer to parts inventory for guidance, and ensure you have all pieces before starting.

When assembling, place all parts on a soft, clean, and flat surface such as a carpet to prevent scratches.

If you're having difficulty, our friendly Customer Care team is always here to help. Call us at **1.888.746.3455** during business hours, email service@article.com or chat live at [article.com](https://www.article.com).

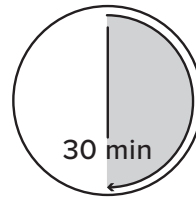



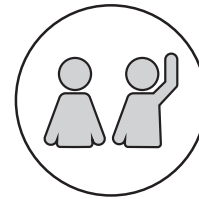

TIME

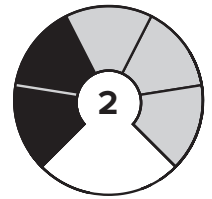

OF PEOPLE



DIFFICULTY

PARTS INVENTORY		
ID	DESCRIPTION	QTY
A	TOP TABLE	1
B	BASE	1
C	FLAT WASHER 	4
D	LOCK WASHER 	4
E	JCBC 8 × 25MM BOLT 	4
F	ALLEN KEY 	1

1

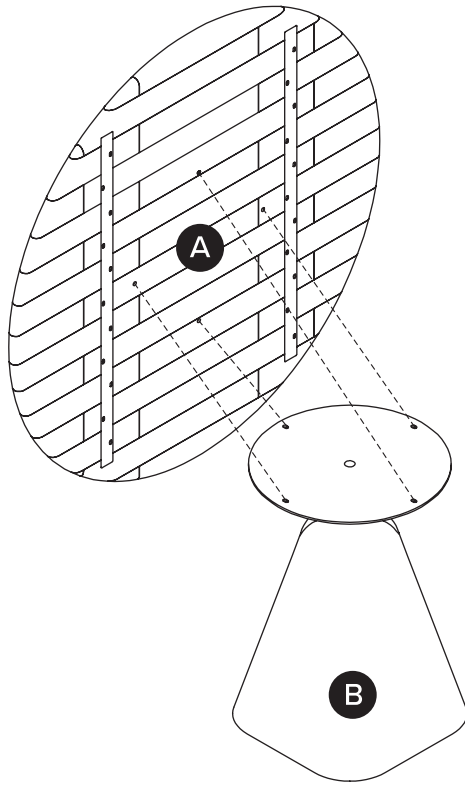

! This item should be assembled on a soft surface to prevent scratching the finish during assembly.

2

