

ARTICLE.

VERSION 1.0

Assembly Instructions

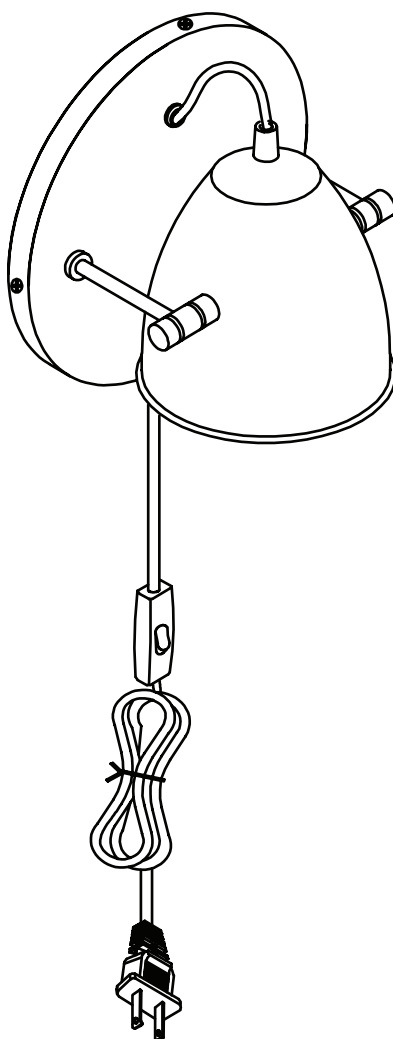

FILA

Sconce

ASSEMBLY INSTRUCTIONS

Read these instructions carefully and keep for future reference. Refer to parts inventory for guidance, and ensure you have all pieces before starting.

When assembling, place all parts on a soft, clean, and flat surface such as a carpet to prevent scratches.

If you're having difficulty, our friendly Customer Care team is always here to help. Call us at **1.888.746.3455** during business hours, email service@article.com or chat live at article.com.

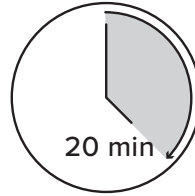

TIME

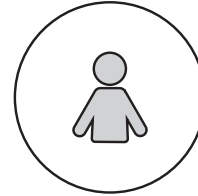

OF PEOPLE

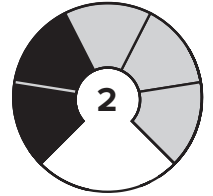

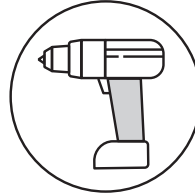

DIFFICULTY

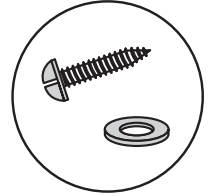
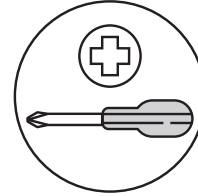

REQUIRED TOOLS



REQUIRED HARDWARE

| PARTS INVENTORY | | |
|-----------------|--|-----|
| ID | DESCRIPTION | QTY |
| A | LAMP BASE | 1 |
| B | WALL BRACKET  | 1 |
| C | SIDE SCREW  | 3 |
| D | BULB (E12 G50 4W LED) | 1 |

1A

1B

! Hardware to attach bracket (B) to wall is not included. Consult with your local hardware store about mounting this lamp to your wall.

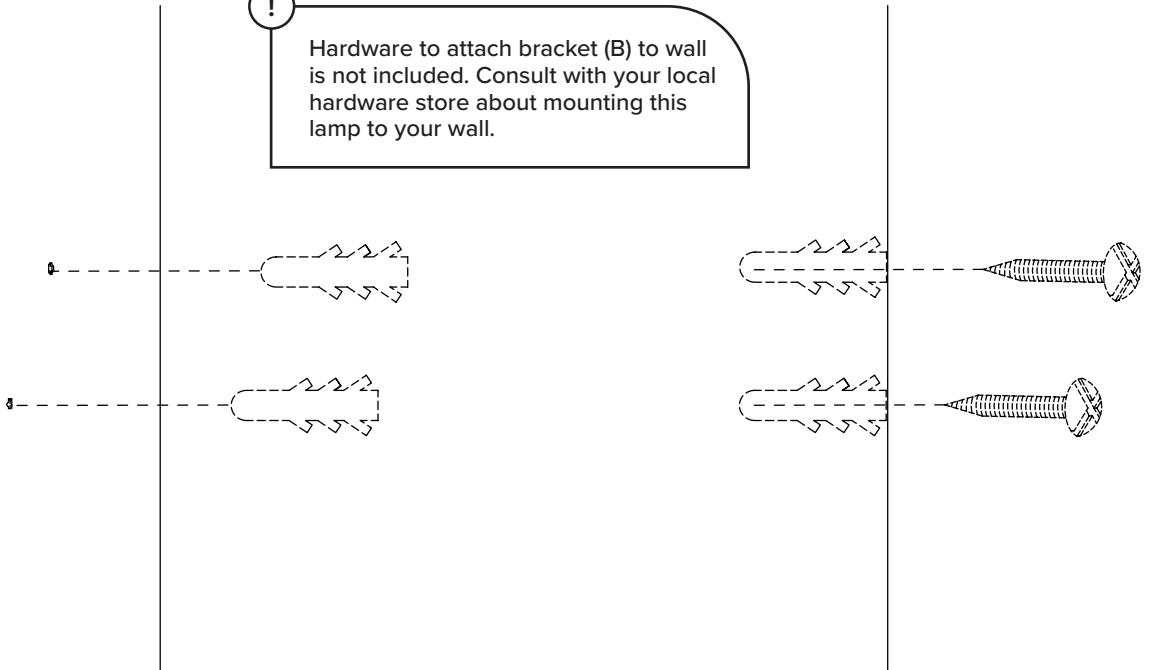

2A

2B

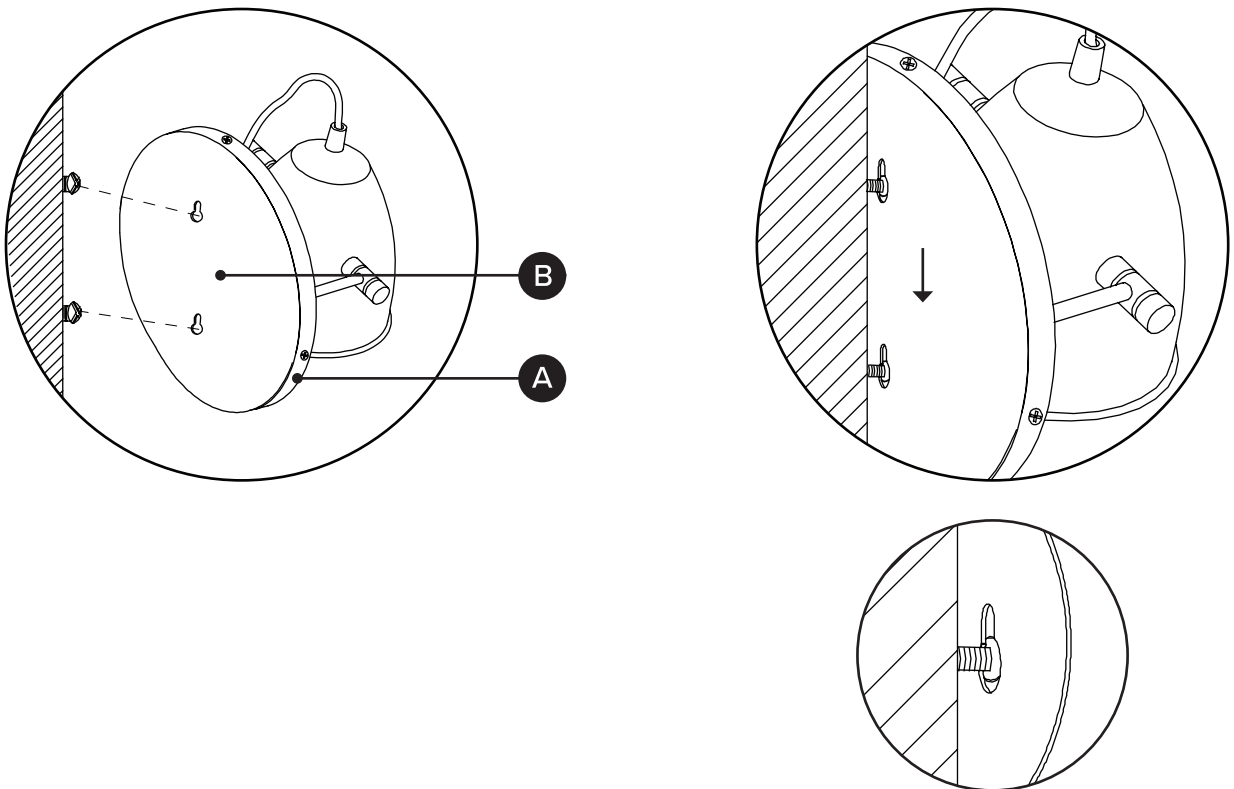

3

