

ARTICLE.

VERSION 1.0

Assembly Instructions

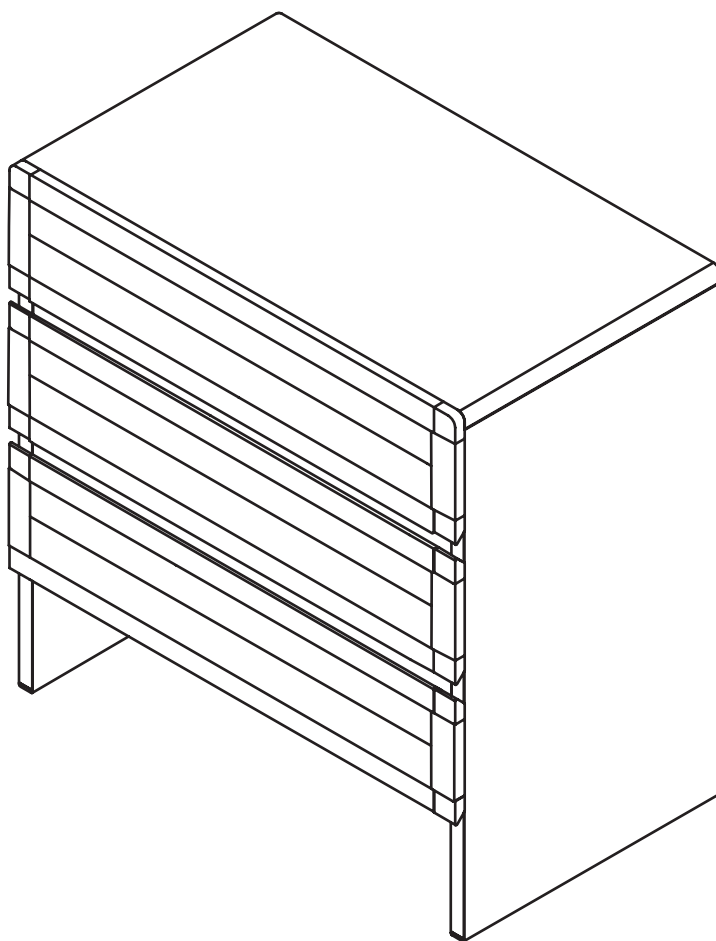

MONTEREY

3 Drawer Dresser



ANTI-TIP RESTRAINT INSTALLATION

WARNING!

Children have died from furniture tipover.
To reduce the risk of furniture tipover:

- ALWAYS install tipover restraint provided.
- NEVER put a TV on this product.
- NEVER allow children to stand, climb or hang on drawers, doors, or shelves.
- NEVER open more than one drawer at a time.
- Place heaviest items in the lower drawers.

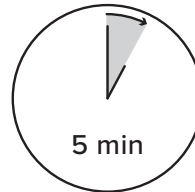

TIME

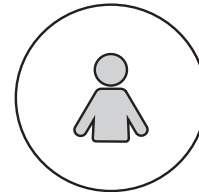

OF PEOPLE

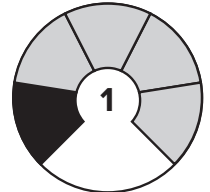



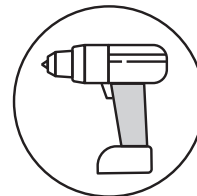

DIFFICULTY

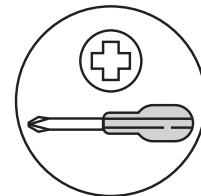

REQUIRED TOOL

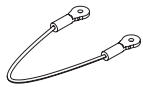

REQUIRED TOOL

PARTS INVENTORY			
ID	DESCRIPTION		QTY
A	M8 × 38MM SCREW		4
B	M8 × 15MM SCREW		4
C	WALL BRACKET		4
D	AIRCRAFT CABLE		2
E	CLEVIS PIN		4
F	HAIR CLIP		4



Hardware (B/C) to attach brackets to wall is designed for drywall. To attach this unit to another type of wall, consult with your local hardware store.

1

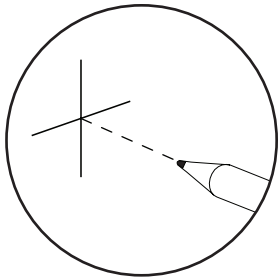

Mark on wall where brackets should be placed.

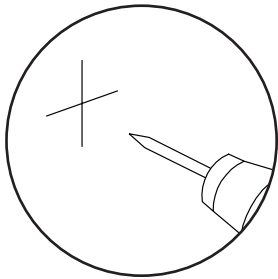

Drill hole in the wall using the drill bit.

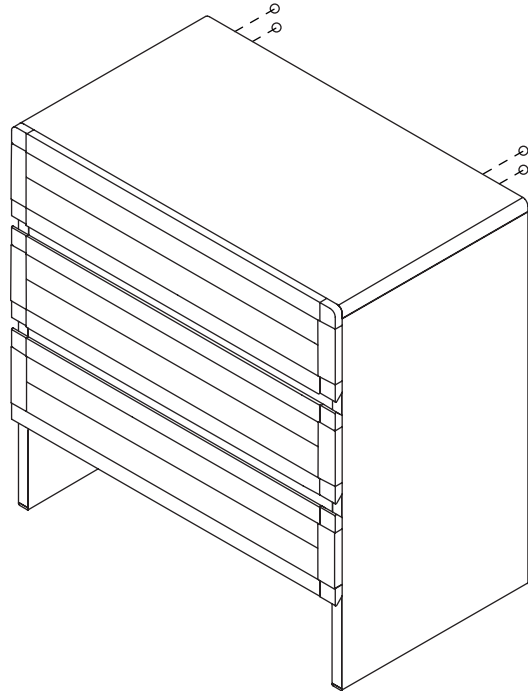

2

