

# ARTICLE.

VERSION 1.0

## Assembly Instructions

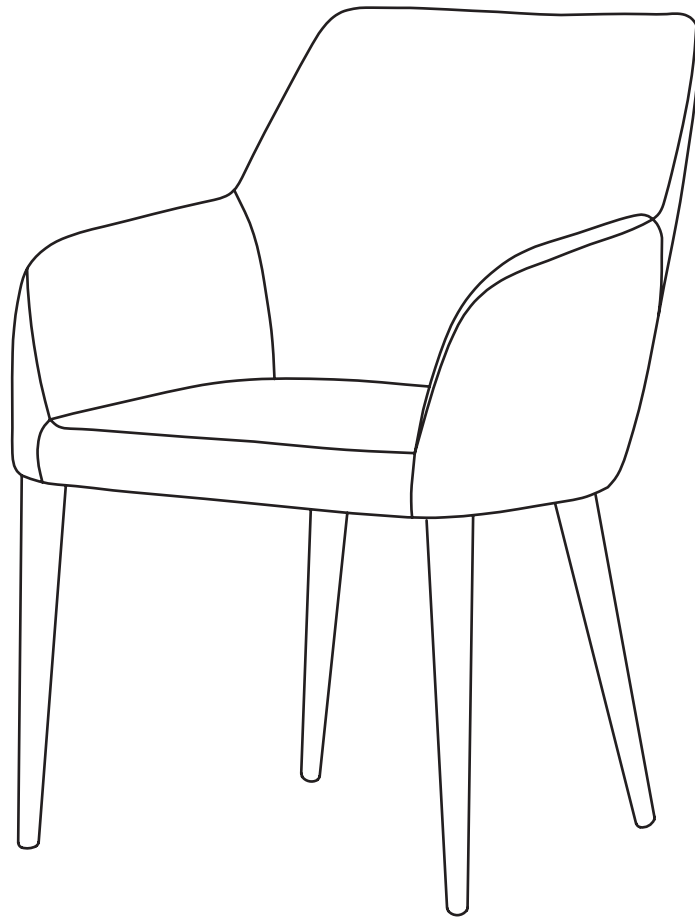

# FEAST

Dining Chair

## ASSEMBLY INSTRUCTIONS

Read these instructions carefully and keep for future reference. Refer to parts inventory for guidance, and ensure you have all pieces before starting.

When assembling, place all parts on a soft, clean, and flat surface such as a carpet to prevent scratches.

If you're having difficulty, our friendly Customer Care team is always here to help. Call us at **1.888.746.3455** during business hours, email [service@article.com](mailto:service@article.com) or chat live at [article.com](https://www.article.com).

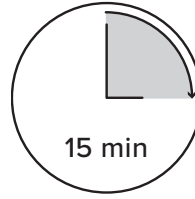





TIME

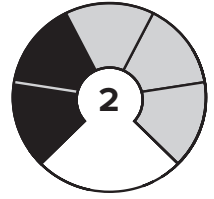

# OF PEOPLE



DIFFICULTY

PARTS INVENTORY		
ID	DESCRIPTION	QTY
<b>A</b>	SEAT 	1
<b>B</b>	BACK LEG 	2
<b>C</b>	FRONT LEG 	2
<b>D</b>	ALLEN KEY 	1
<b>E</b>	M8 x 40MM BOLT 	12

1

! Attach back leg (B) and front leg (C) to seat (A) respectively with bolts (E). Make sure to tighten all bolts.

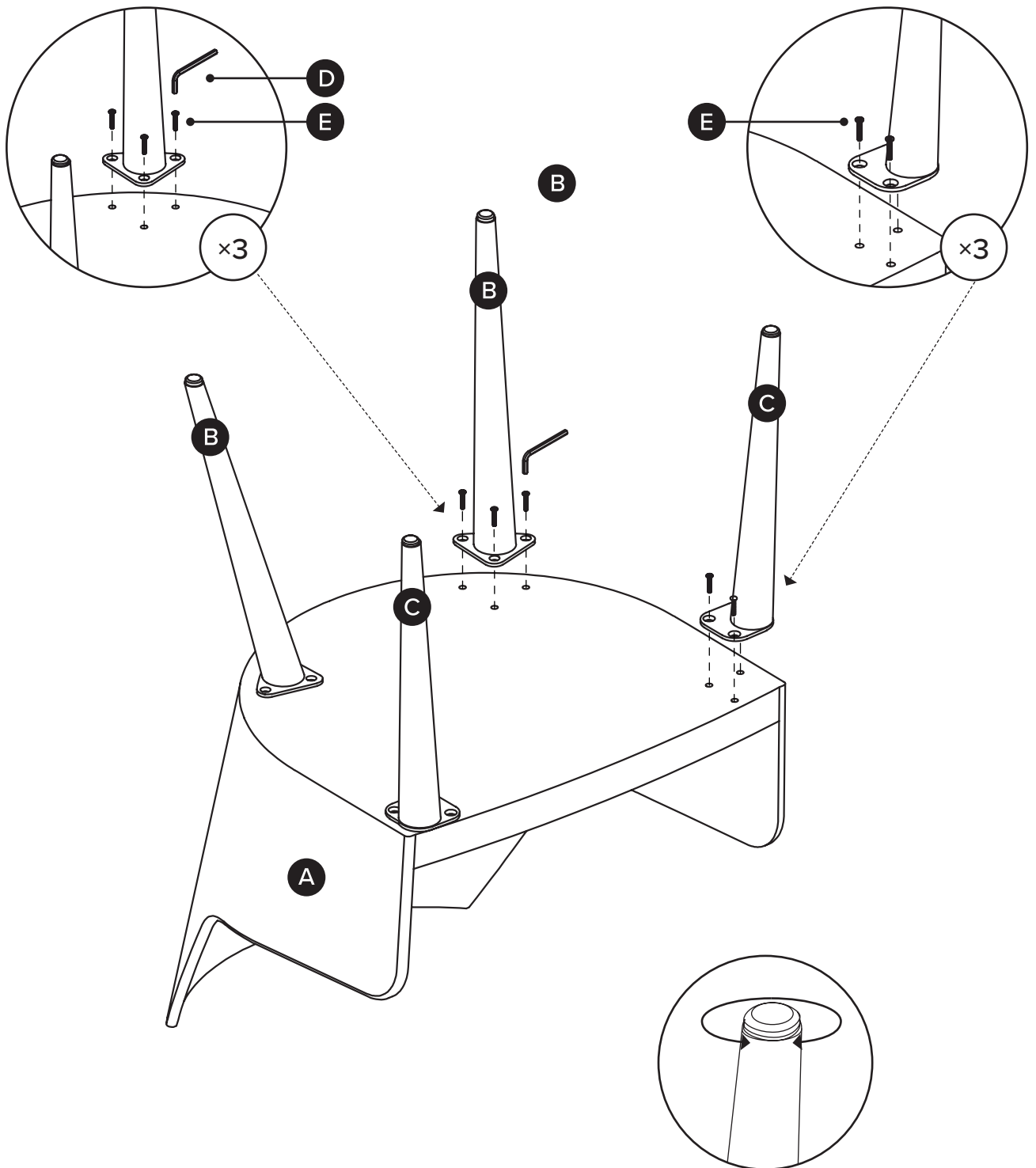

! Adjust levelers as needed.