

ARTICLE.

VERSION 1.0

Assembly Instructions

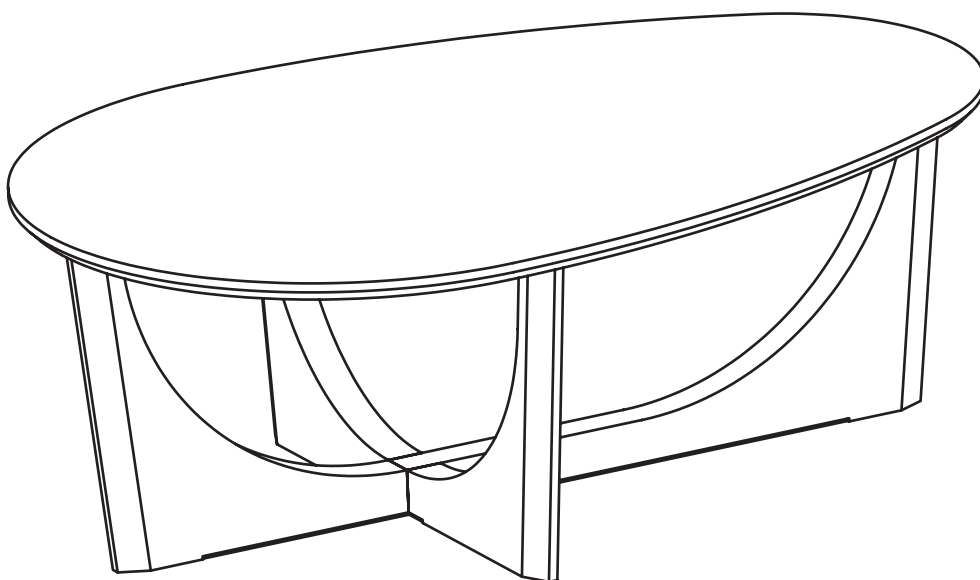

TOVI

Coffee Table

ASSEMBLY INSTRUCTIONS

Read these instructions carefully and keep for future reference. Refer to parts inventory for guidance, and ensure you have all pieces before starting.

When assembling, place all parts on a soft, clean, and flat surface such as a carpet to prevent scratches.

If you're having difficulty, our friendly Customer Care team is always here to help. Call us at **1.888.746.3455** during business hours, email service@article.com or chat live at [article.com](https://www.article.com).

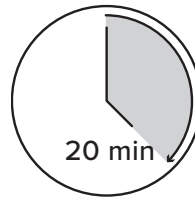



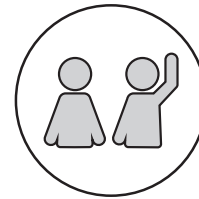

TIME

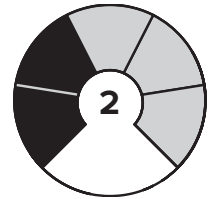

OF PEOPLE

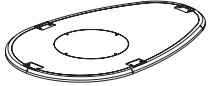
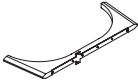

DIFFICULTY

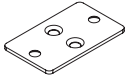
PARTS INVENTORY		
ID	DESCRIPTION	QTY
A	TABLE TOP 	1
B	CENTRAL LEG 	1
C	SIDE LEG 	2
D	ALLEN KEY 	1
E	M6 × 15MM BOLT 	18
F	52 × 86MM STEEL PAT 	4

1

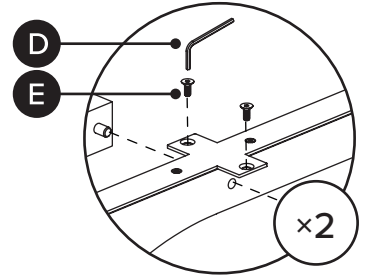
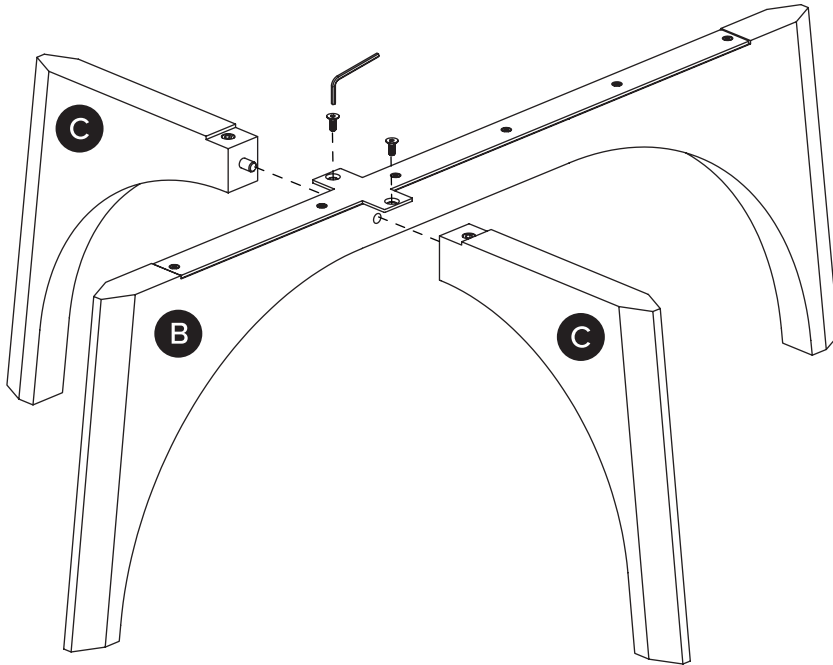

2

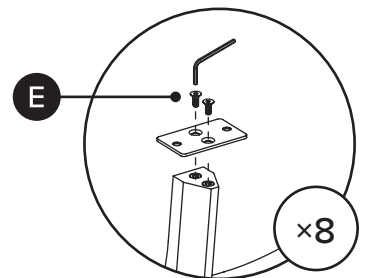
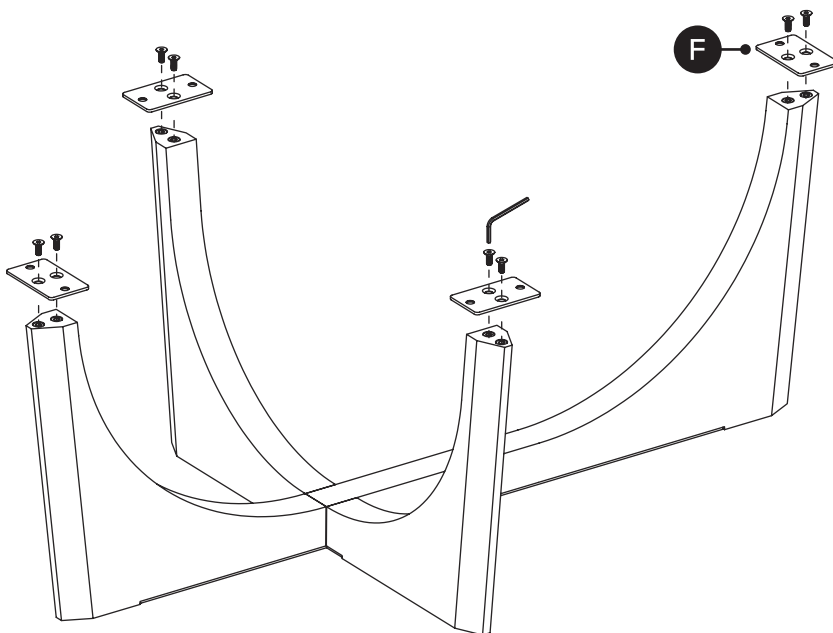

3

