

ARTICLE.

VERSION 1.0

Assembly Instructions

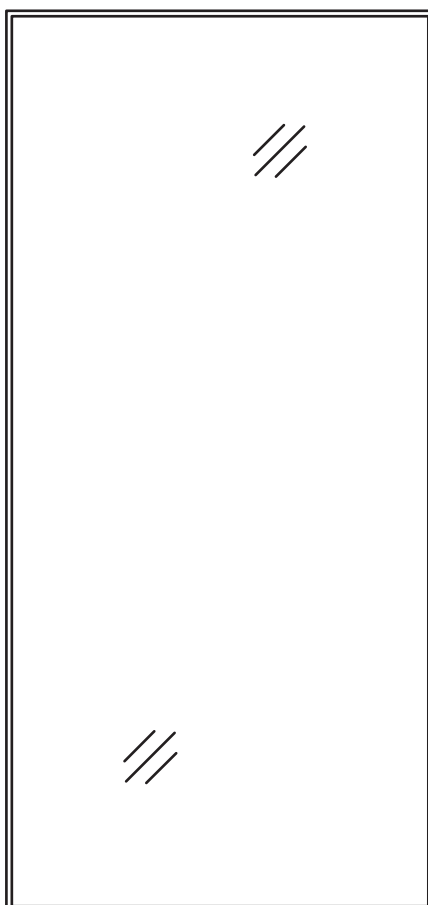

VEERE

Floor Mirror



ANTI-TIP RESTRAINT INSTALLATION

WARNING!

Serious or fatal crushing injuries can occur from furniture tip-over. To help prevent tip-over:

- Install tip-over restraint provided.
- Do not set heavy objects on top of this product, unless the product is specifically designed to accommodate them.
- Never allow children to climb or hang on mirrors, shelves, consoles, or cabinets with doors and/or drawers.

Use of tip-over restraints may only reduce but not eliminate, the risk of tip-over.

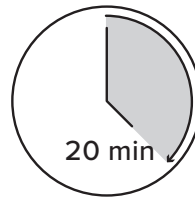

20 min

TIME

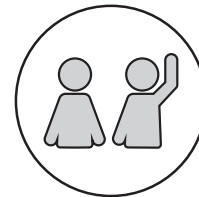

OF PEOPLE

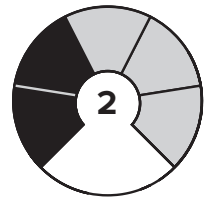



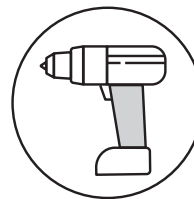

DIFFICULTY

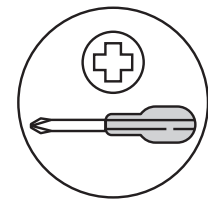

REQUIRED TOOL
8MM / 5/16" DRILL BIT



REQUIRED TOOL

PARTS INVENTORY		
ID	DESCRIPTION	QTY
A	PLUG 	4
B	M4 × 25MM SCREW 	4
C	BRACKET 	2
D	QUICK LINK CABLE 	2



Hardware (A/B) to attach brackets to wall is designed for drywall. To attach this unit to another type of wall, consult with your local hardware store.

1

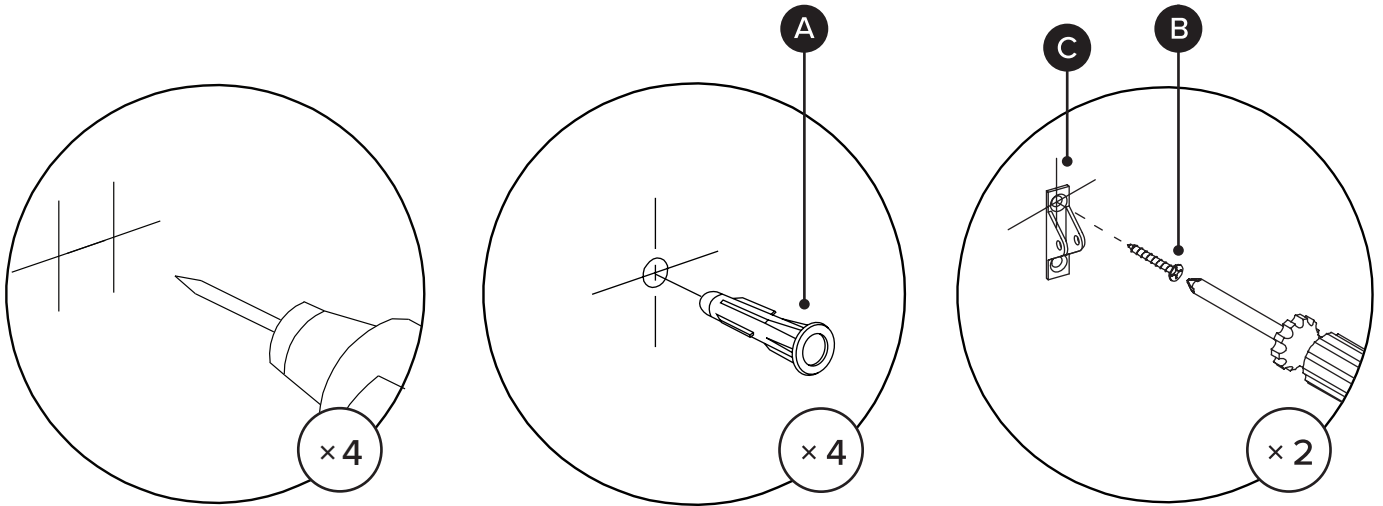

Drill holes in wall using 8mm / 5/16" drill bit.

2

! Quick link cable (D) through pre-installed brackets (C) onto mirror. Thread through brackets (C) on the wall. To lock, link cable until they snap lock.

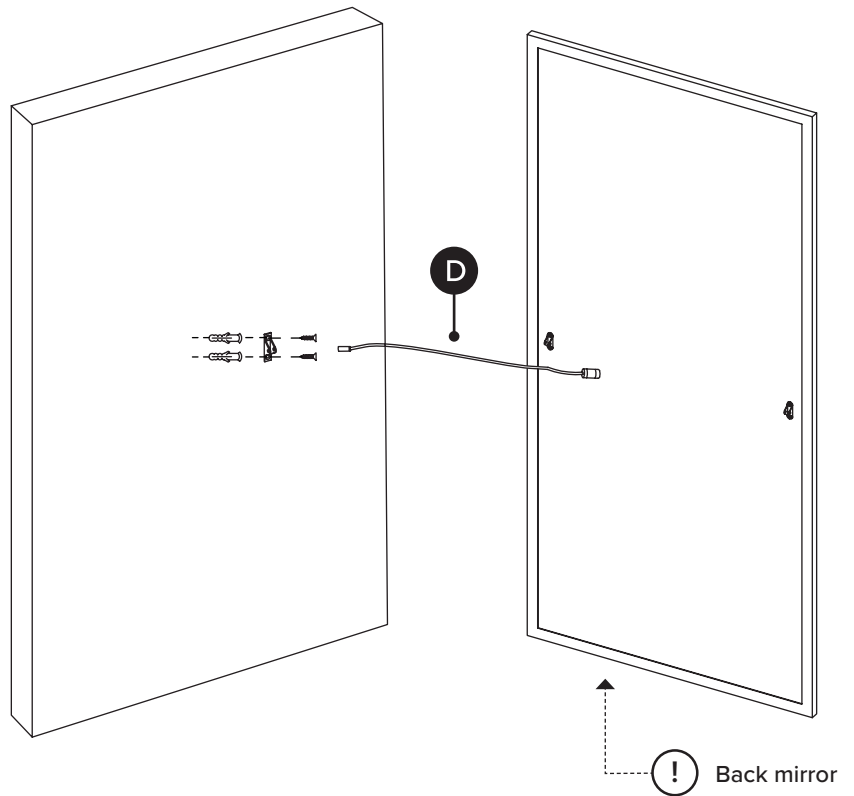

3

