

ARTICLE.

VERSION 1.0

Assembly Instructions

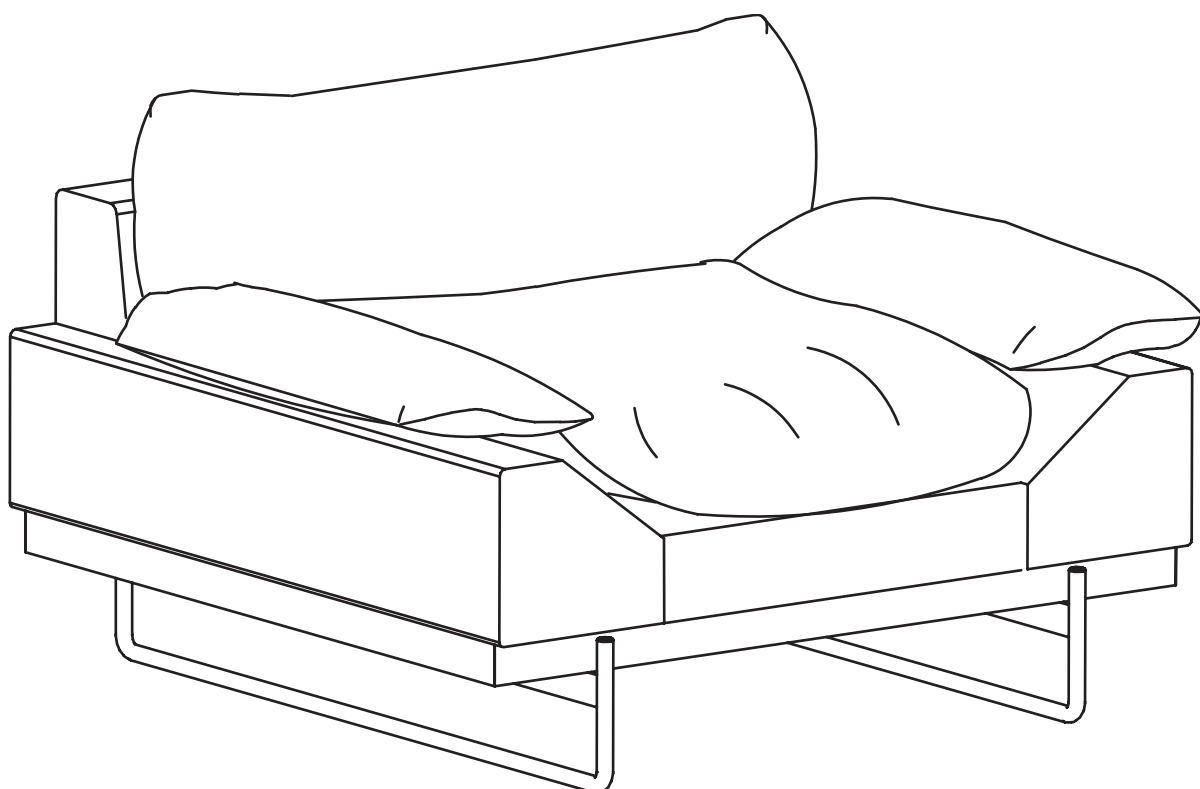

DAHLINO

Chair

ASSEMBLY INSTRUCTIONS

Read these instructions carefully and keep for future reference. Refer to parts inventory for guidance, and ensure you have all pieces before starting.

When assembling, place all parts on a soft, clean, and flat surface such as a carpet to prevent scratches.

If you're having difficulty, our friendly Customer Care team is always here to help. Call us at **1.888.746.3455** during business hours, email service@article.com or chat live at [article.com](https://www.article.com).

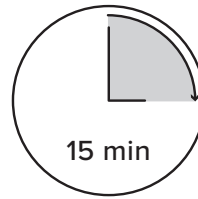

15 min

TIME

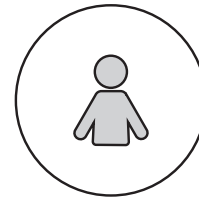



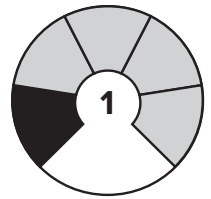

OF PEOPLE





1

DIFFICULTY

! Hardware may loosen over time, check the bolts regularly and tighten if necessary.

PARTS INVENTORY		
ID	DESCRIPTION	QTY
A	METAL LEG	2
B	ALLEN KEY 	1
C	BOLT 	16
D	LOCK WASHER 	16
E	WASHER 	16

PARTS INVENTORY		
ID	DESCRIPTION	QTY
F	SEAT CUSHION 	1
G	BACK CUSHION 	1
H	ARM CUSHION 	2

1A

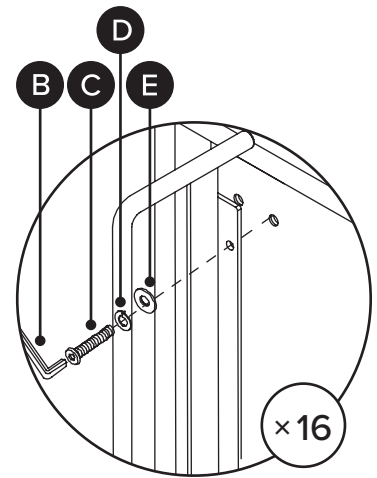
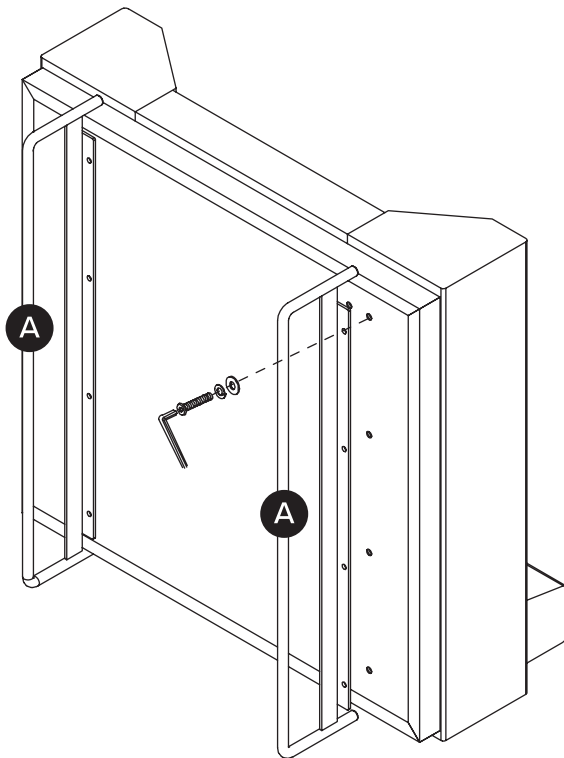

1B

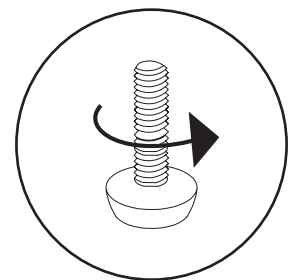
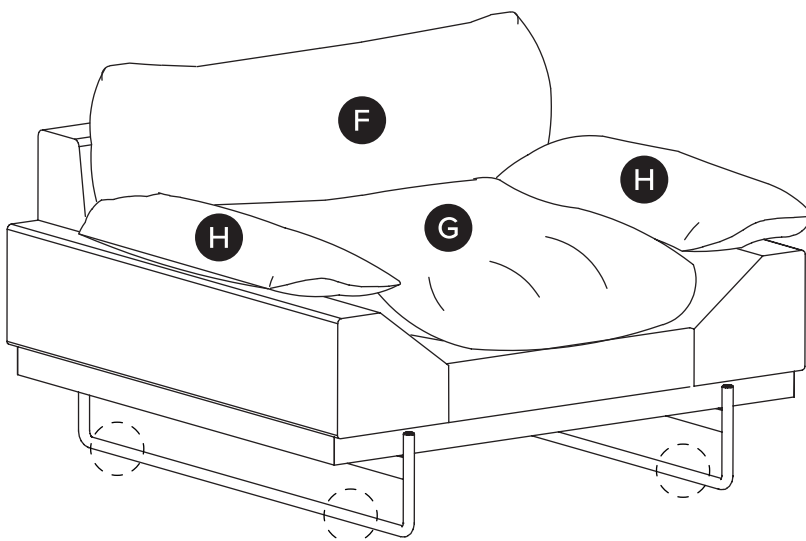

! Adjust levelers as needed.