

ARTICLE.

VERSION 1.0

Assembly Instructions

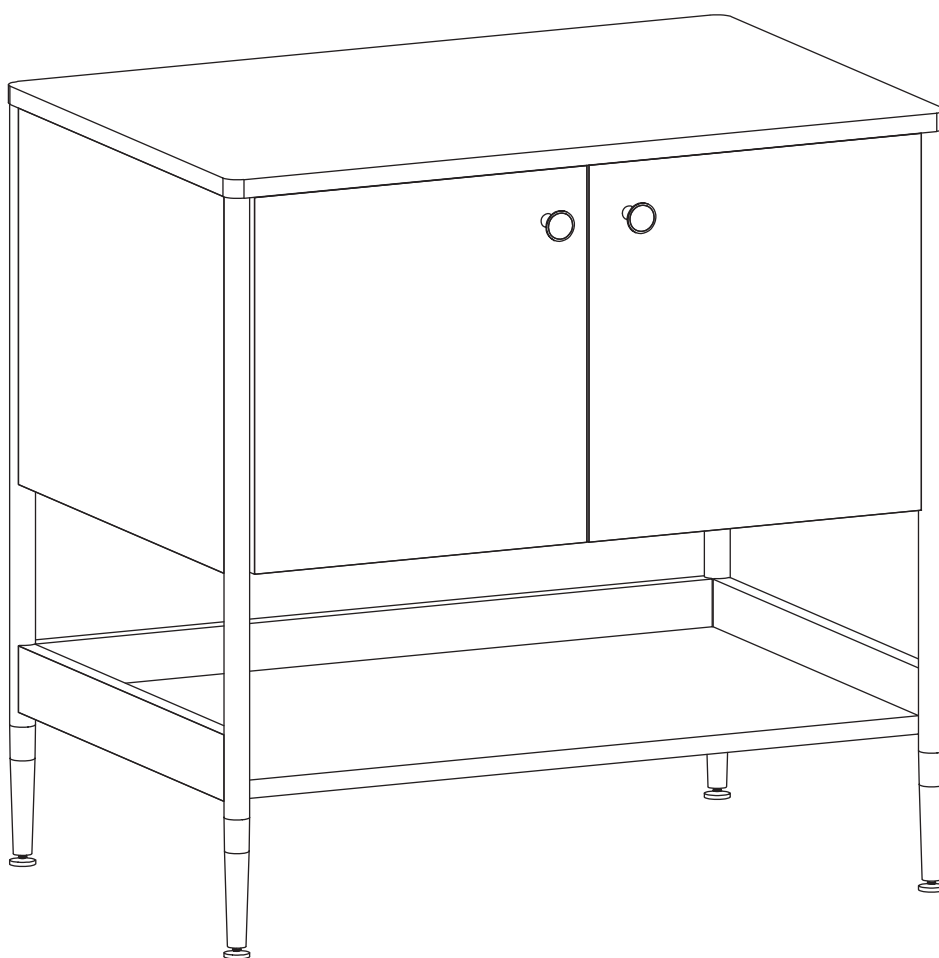

NEWBERRY

Cabinet

ASSEMBLY INSTRUCTIONS

Read these instructions carefully and keep for future reference. Refer to parts inventory for guidance, and ensure you have all pieces before starting.

When assembling, place all parts on a soft, clean, and flat surface such as a carpet to prevent scratches.

If you're having difficulty, our friendly Customer Care team is always here to help. Call us at **1.888.746.3455** during business hours, email service@article.com or chat live at [article.com](https://www.article.com).

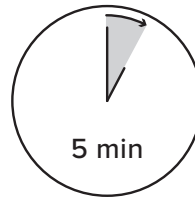

5 min

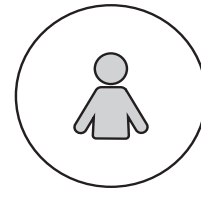

TIME

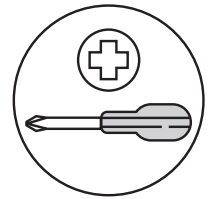

OF PEOPLE



REQUIRED TOOL

PARTS INVENTORY		
ID	DESCRIPTION	QTY
A	HANDLE 	2
B	SCREWS 	2
C	CABINET	1

1

 Use screwdriver to install handle (A) to the door with screw (B).

