

ARTICLE.

VERSION 1.0

Assembly Instructions

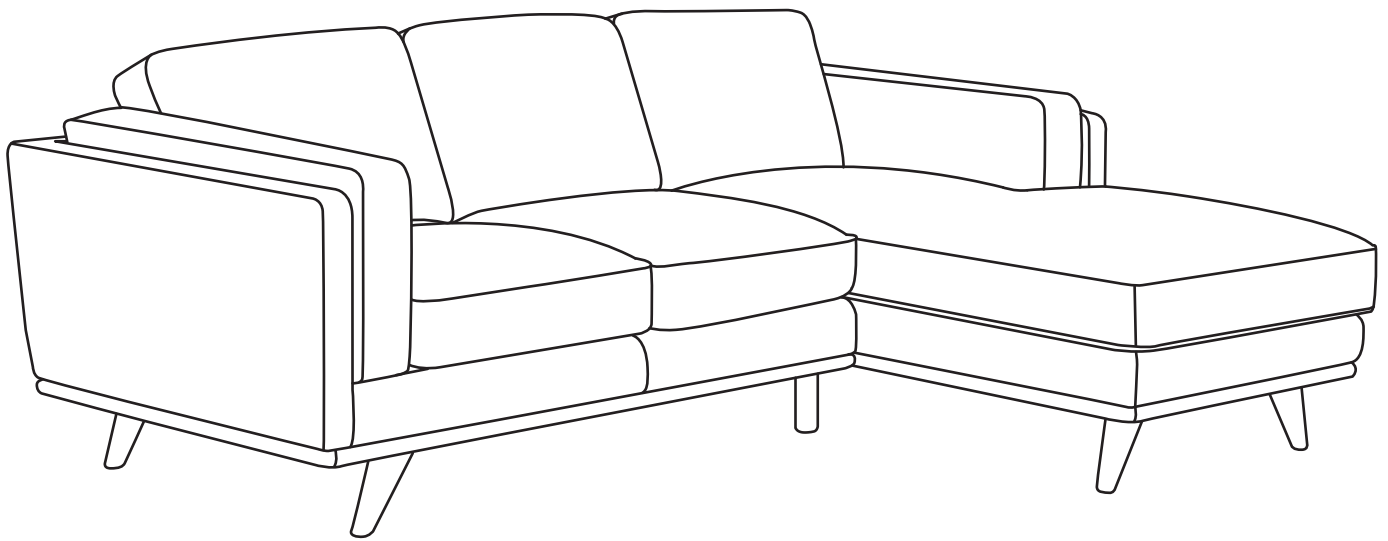

TIMBER

Right Sectional Sofa

ASSEMBLY INSTRUCTIONS

Read these instructions carefully and keep for future reference. Refer to parts inventory for guidance, and ensure you have all pieces before starting.

When assembling, place all parts on a soft, clean, and flat surface such as a carpet to prevent scratches.

If you're having difficulty, our friendly Customer Care team is always here to help. Call us at **1.888.746.3455** during business hours, email service@article.com or chat live at [article.com](https://www.article.com).

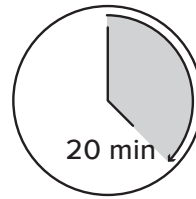

TIME





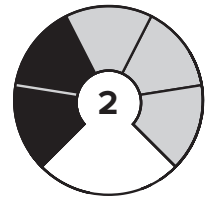







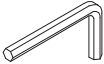

OF PEOPLE



DIFFICULTY

! Hardware may loosen over time, check the bolts regularly and tighten if necessary.

PARTS INVENTORY			
ID	DESCRIPTION		QTY
A	SOFA SECTION		1
B	RIGHT CHAISE SECTION		1
C	CORNER LEGS		5
D	INSIDE LEGS		3
E	ALLEN KEY		2
F	M10 × 60MM BOLT		5
G	LOCK WASHER		5
H	WASHER		5

PARTS INVENTORY CONT.			
ID	DESCRIPTION		QTY
I	ARM CUSHION		2
J	SHORT SEAT CUSHION		2
K	LONG SEAT CUSHION		1
L	BACK CUSHION		3

1A

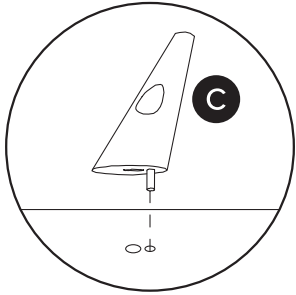

! Align dowels and insert legs (C) into sofa first.

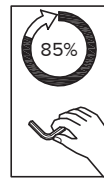
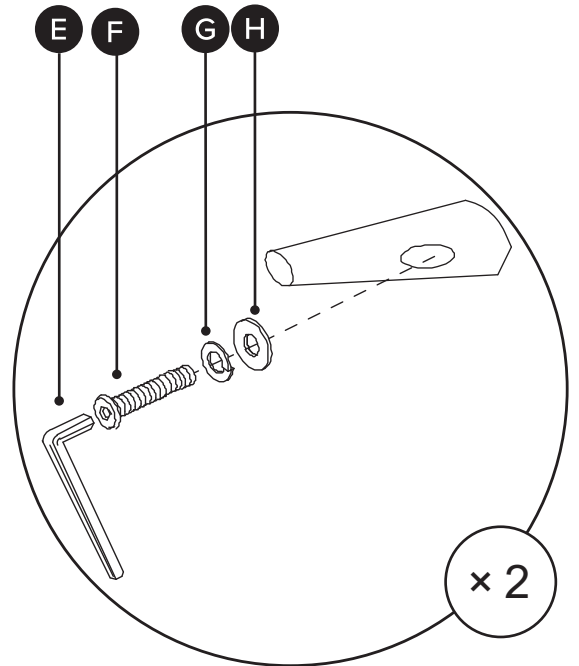
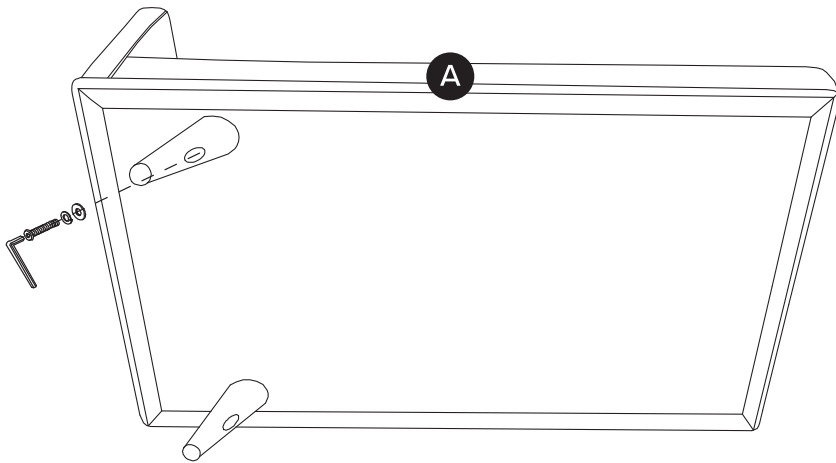

! Insert bolt (F) and washers (G/H) through hole on legs. Do not fully tighten right away.

1B

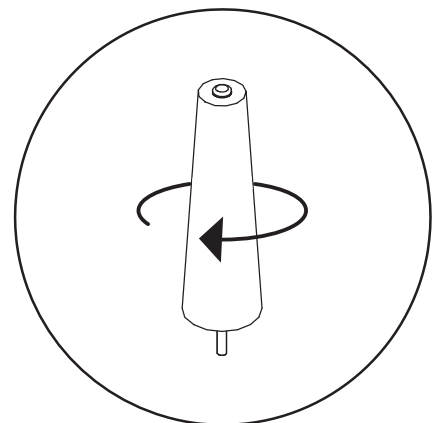
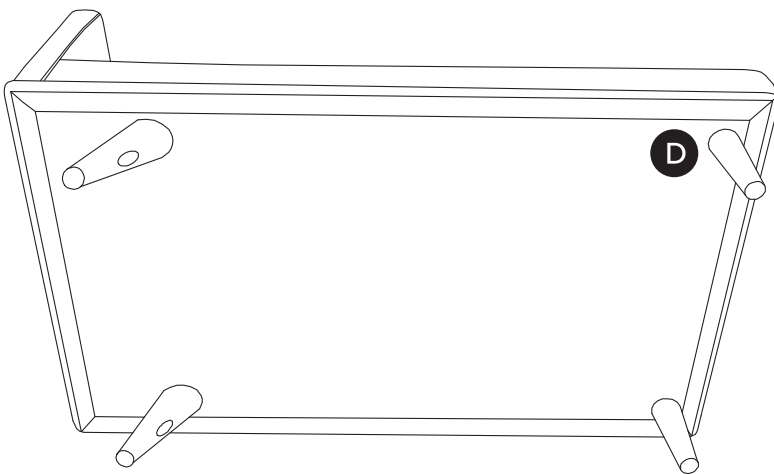

2A

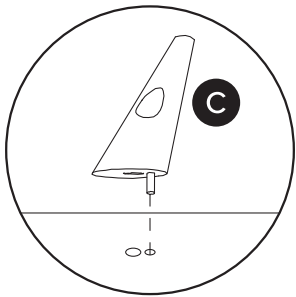

! Align dowels and insert legs (C) into sofa first.

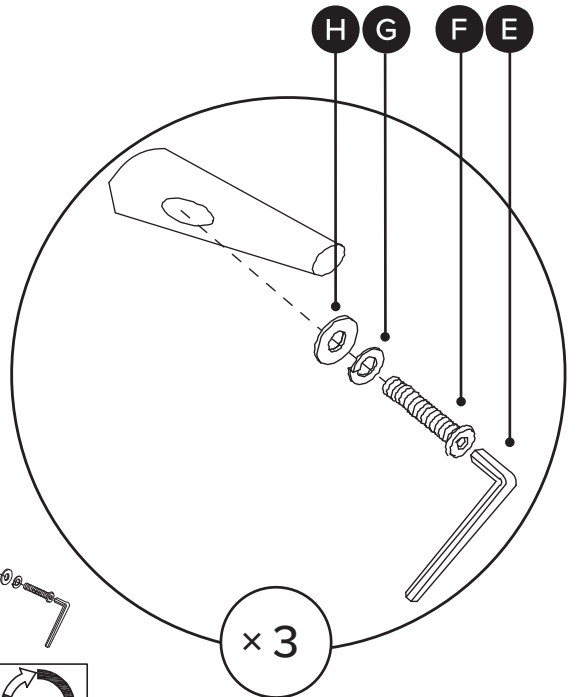
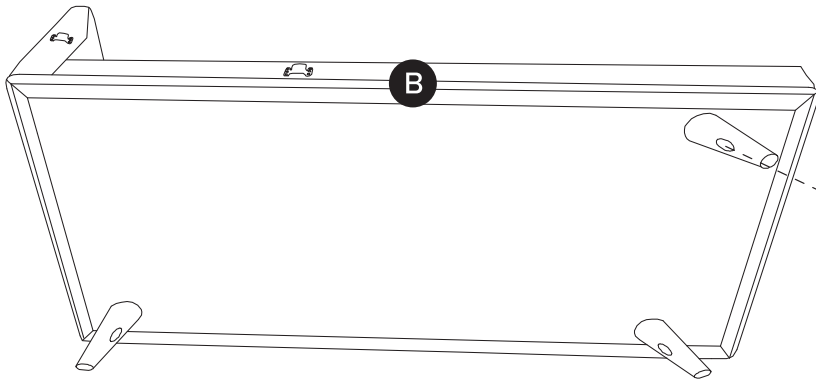

! Insert bolt (F) and washers (G/H) through hole on legs. Do not fully tighten right away.

2B

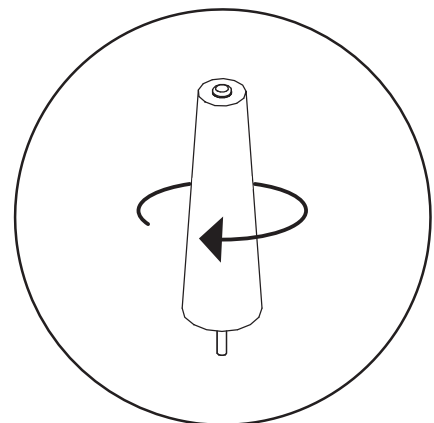
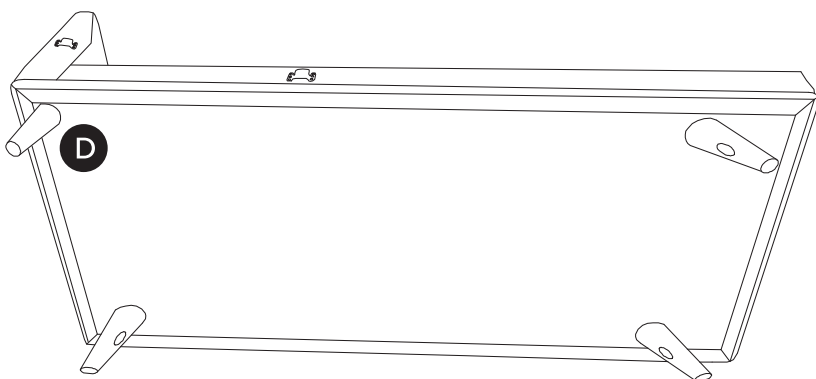

3



Check leg angles are all correct before fully tightening. Fully tightened bolts ensure leg stability when moving sofa.

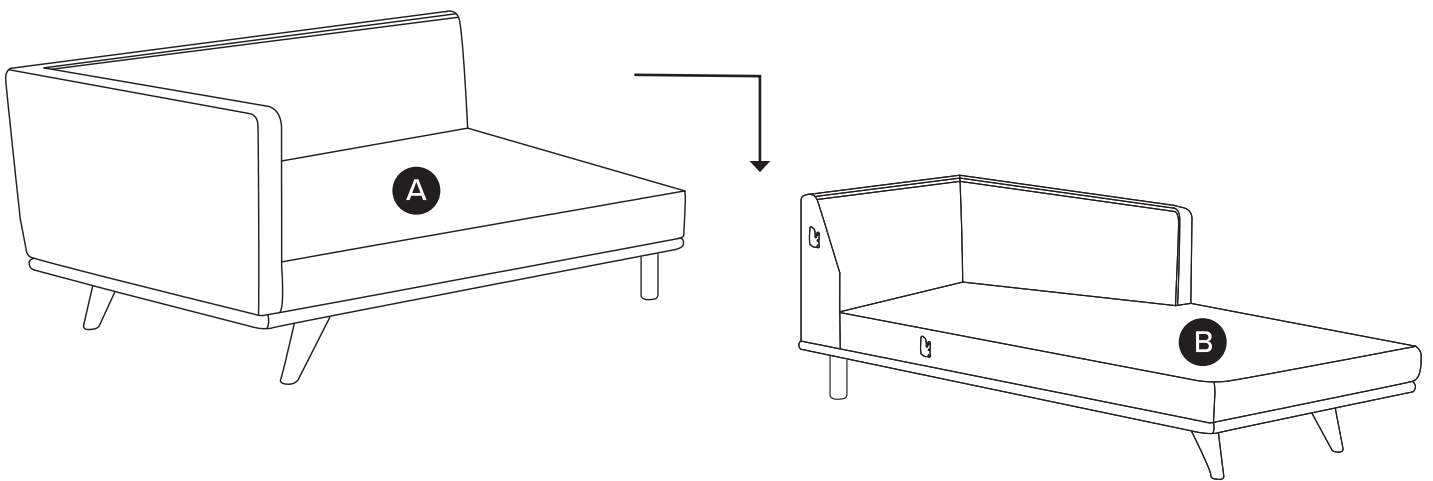

Attach both back and front connectors at the same time.

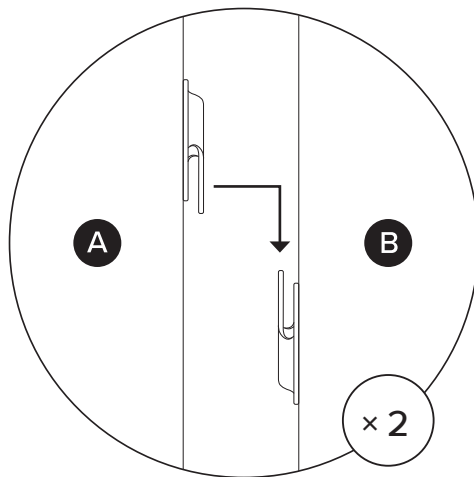

Place side cushions on sofa first before seat cushions.

4

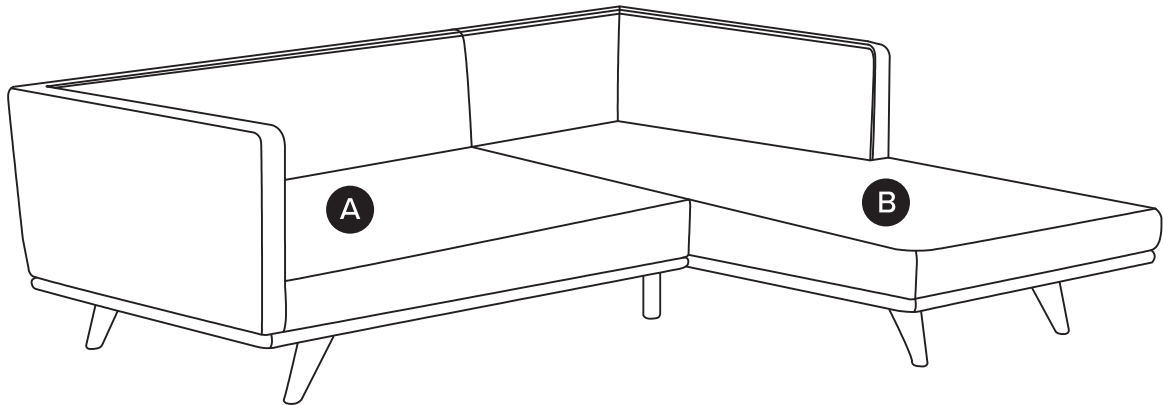

5

! Slanted sides of arm cushions (I) fit to the back of the sofa.

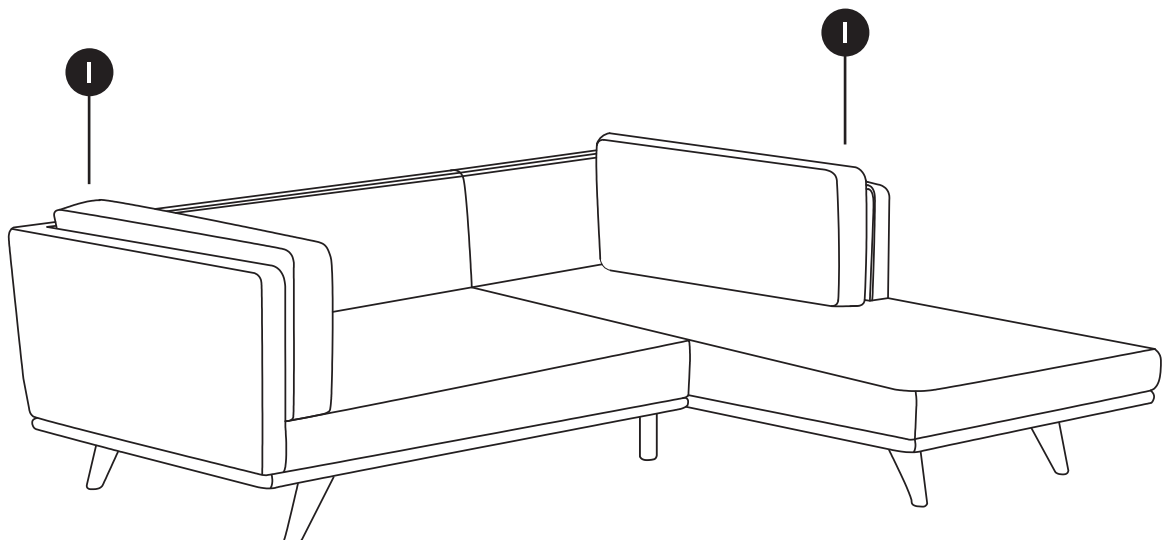

6

! Place seat cushions (J) ,(K) fit to the back of the sectional.

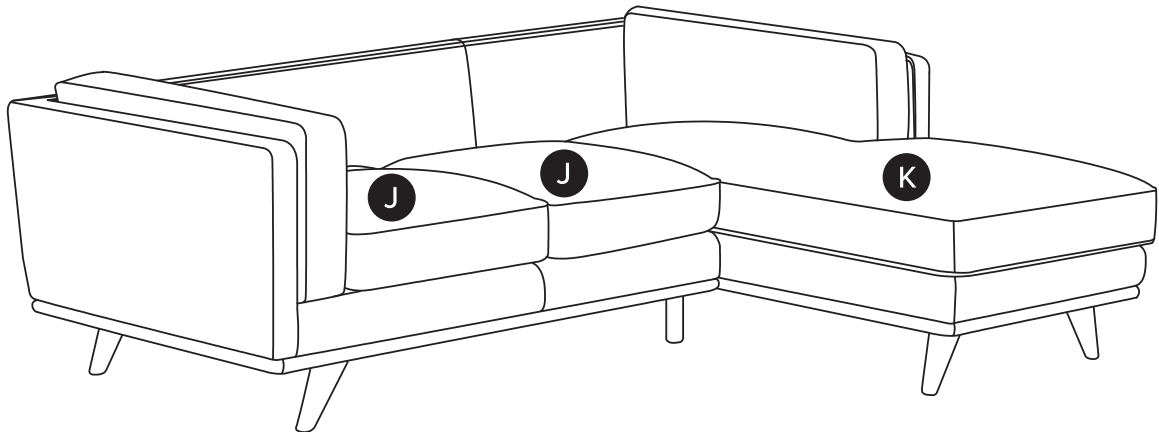

7

! Place back cushions (L) fit to the back of the sectional.

