

ARTICLE.

VERSION 1.0

Assembly Instructions

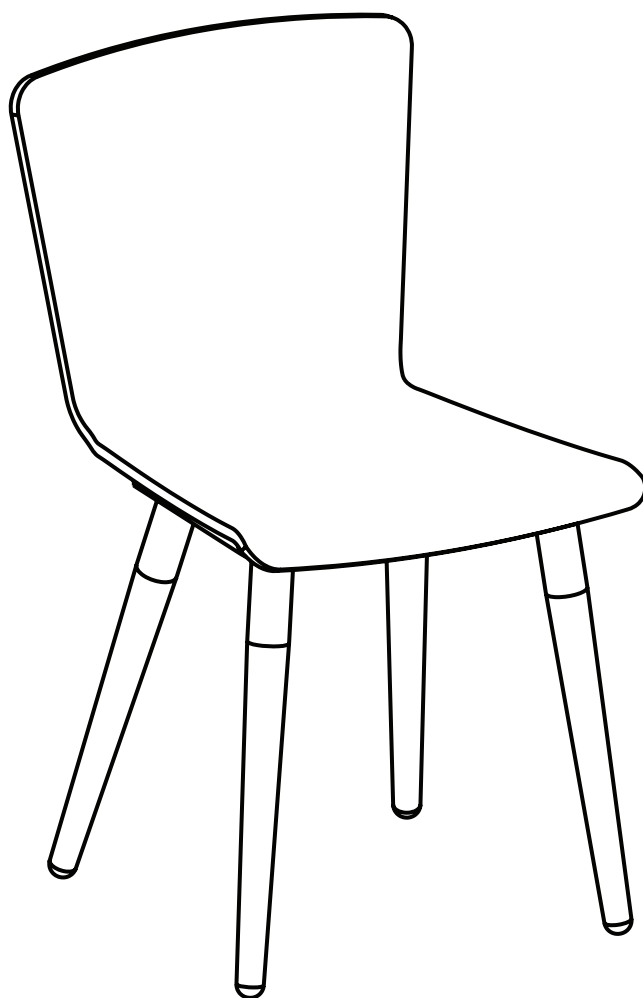

SEDE

Dining Chair (Plywood Seat)

ASSEMBLY INSTRUCTIONS

Read these instructions carefully and keep for future reference. Refer to parts inventory for guidance, and ensure you have all pieces before starting.

When assembling, place all parts on a soft, clean, and flat surface such as a carpet to prevent scratches.

If you're having difficulty, our friendly Customer Care team is always here to help. Call us at **1.888.746.3455** during business hours, email service@article.com or chat live at [article.com](https://www.article.com).

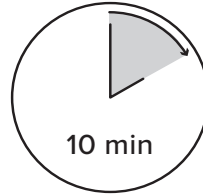

10 min





TIME

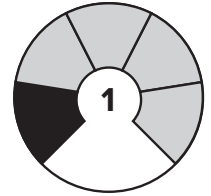

OF PEOPLE

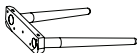
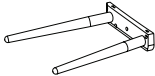

DIFFICULTY

PARTS INVENTORY		
ID	DESCRIPTION	QTY
A	SEAT 	1
B	LEFT LEG 	1
C	RIGHT LEG 	1
D	ALLEN KEY 	1
E	M6 × 25MM BOLT 	20
F	M6 × 10MM LOCK WASHER 	20
G	M6 × 12MM WASHER 	20

1

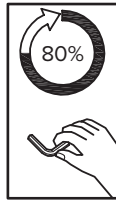

! Do not fully tighten bolts until all bolts are placed properly.

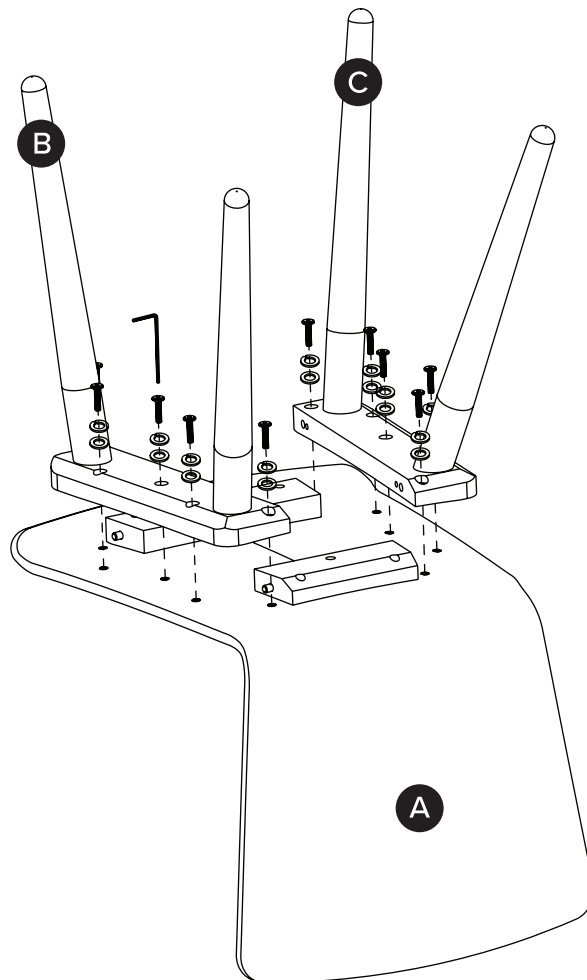
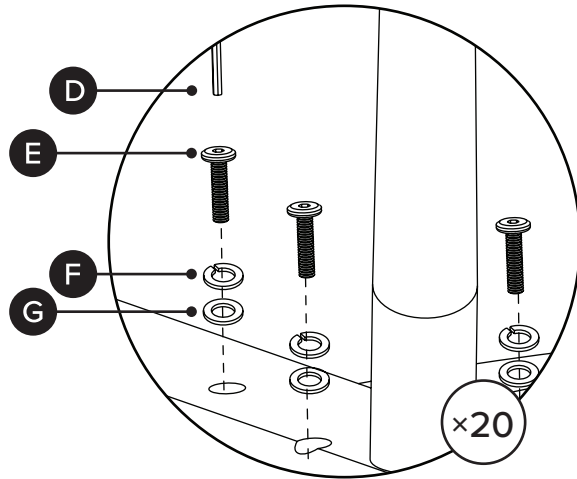

2



! Tighten all bolts 100%.

! It is important that all bolts are retightened 2 weeks after assembly. Once every 2 months in order to assure stability throughout the lifespan of this product.

