

ARTICLE.

VERSION 1.2

Assembly Instructions

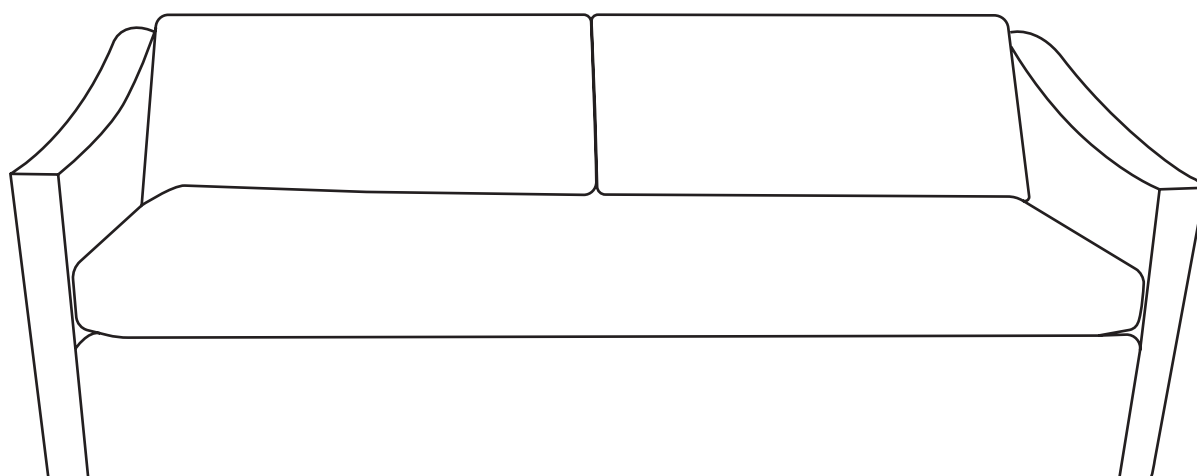

LANDRY

Sofabed

ASSEMBLY INSTRUCTIONS

Read these instructions carefully and keep for future reference. Refer to parts inventory for guidance, and ensure you have all pieces before starting.

When assembling, place all parts on a soft, clean, and flat surface such as a carpet to prevent scratches.

If you're having difficulty, our friendly Customer Care team is always here to help. Call us at **1.888.746.3455** during business hours, email service@article.com or chat live at [article.com](https://www.article.com).

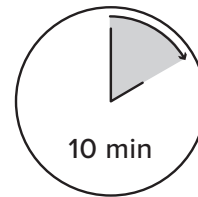

10 min

TIME

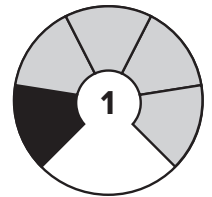

DIFFICULTY

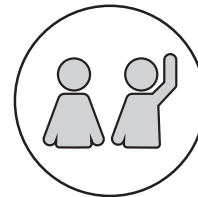

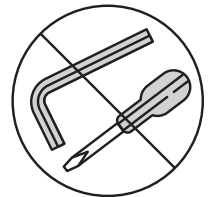

OF PEOPLE



TOOL FREE

! Hardware may loosen over time, check the bolts regularly and tighten if necessary.

PARTS INVENTORY		
ID	DESCRIPTION	QTY
A	SEAT CUSHION 	1
B	BACK CUSHION 	2

1

! Before pulling out of the sofabed ensure two wire ties and two straps are removed.

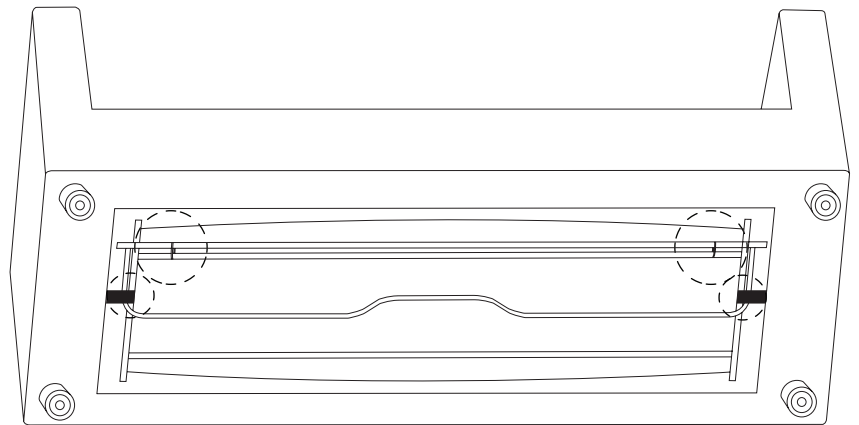
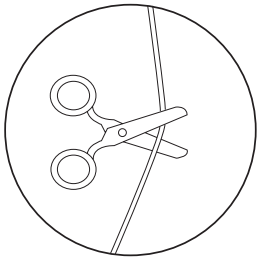

2A

! Use the handle at the front edge of the sofa to pull bed up and out.

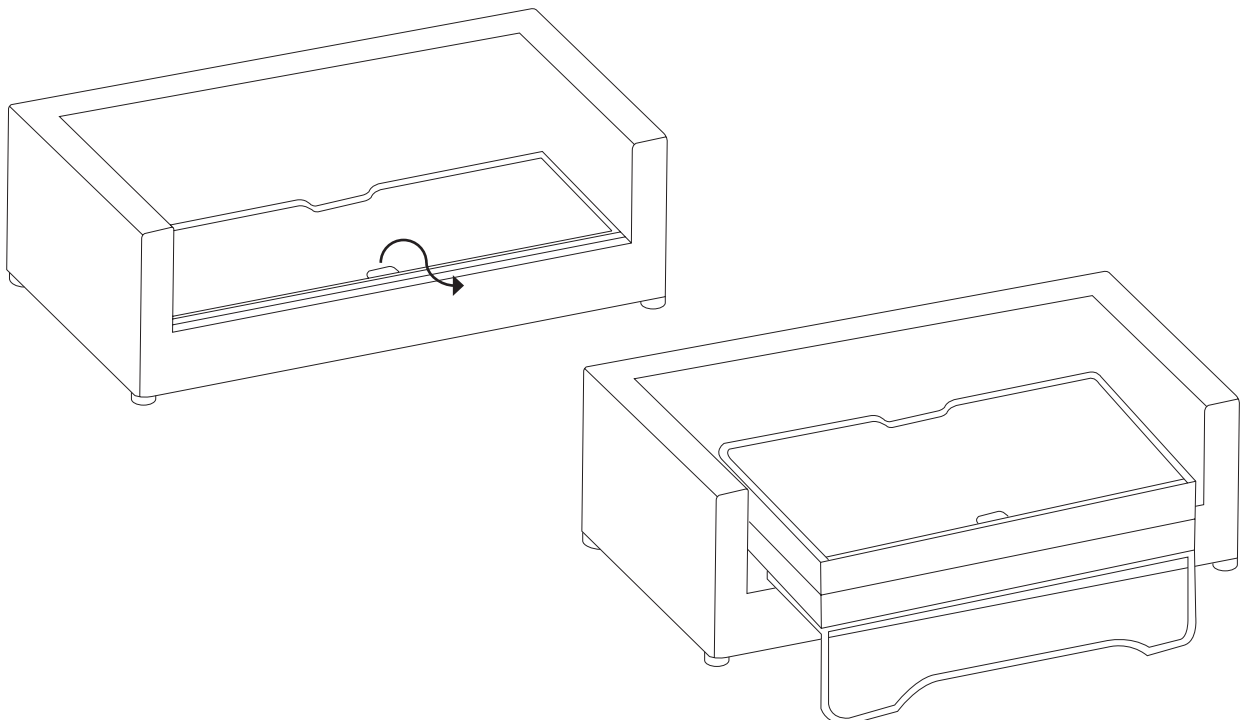

2B

! Pull second leg up, around, and under to unfold mattress.

