

# ARTICLE.

VERSION 1.0

## Assembly Instructions



# GERVEN

Office Chair

## ASSEMBLY INSTRUCTIONS

Read these instructions carefully and keep for future reference. Refer to parts inventory for guidance, and ensure you have all pieces before starting.

When assembling, place all parts on a soft, clean, and flat surface such as a carpet to prevent scratches.

If you're having difficulty, our friendly Customer Care team is always here to help. Call us at **1.888.746.3455** during business hours, email [service@article.com](mailto:service@article.com) or chat live at [article.com](https://www.article.com).

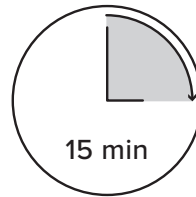

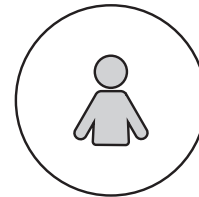

TIME

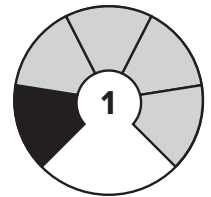

# OF PEOPLE



DIFFICULTY

PARTS INVENTORY		
ID	DESCRIPTION	QTY
<b>A</b>	SEAT 	1
<b>B</b>	LEG 	1
<b>C</b>	GAS LIFT 	1

**!** Due to parts that have sharp edges, please handle unassembled parts carefully.

**!** Never wipe with damp cloth or hard things. Never wave or bump the product too hard. Stock in door after cleaning when not used.

# 1

**!** Insert gas lift (C) to leg (B) as shown.

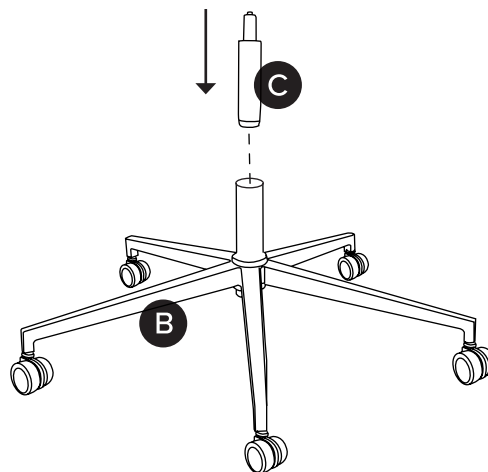

2

! Fit hole of seat (A) into gas lift (C) of leg (B) assembly as shown.

