

ARTICLE.

VERSION 1.0

Assembly Instructions

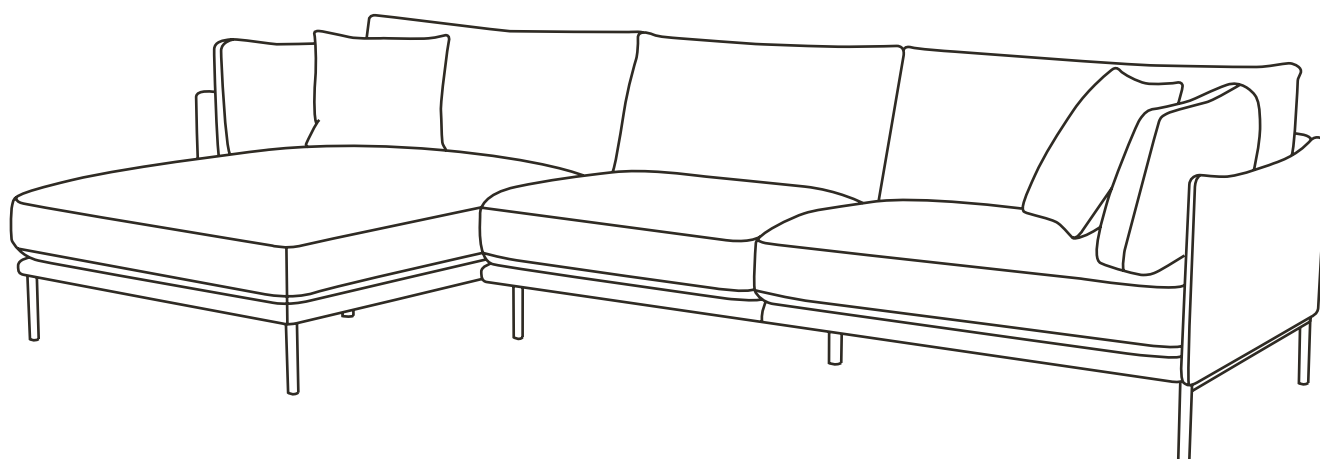

OLSEN

Left Sectional

ASSEMBLY INSTRUCTIONS

Read these instructions carefully and keep for future reference. Refer to parts inventory for guidance, and ensure you have all pieces before starting.

When assembling, place all parts on a soft, clean, and flat surface such as a carpet to prevent scratches.

If you're having difficulty, our friendly Customer Care team is always here to help. Call us at **1.888.746.3455** during business hours, email service@article.com or chat live at [article.com](https://www.article.com).

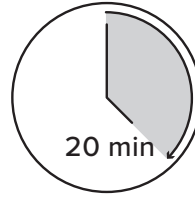

TIME





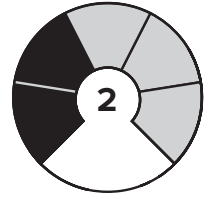

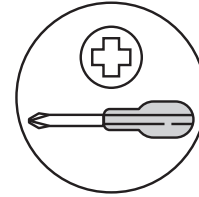

OF PEOPLE



DIFFICULTY



REQUIRED TOOL

PARTS INVENTORY		
ID	DESCRIPTION	QTY
A	CHAISE SECTION	1
B	SOFA SECTION	1
C	METAL LEG BAR 	1
D	CENTER LEG 	2
E	ALLEN KEY 	1
F	CORNER LEG 	6
G	M10 × 40MM BOLT 	2
H	M5 × 40MM SCREW 	2
I	M6 × 25MM BOLT 	24

1

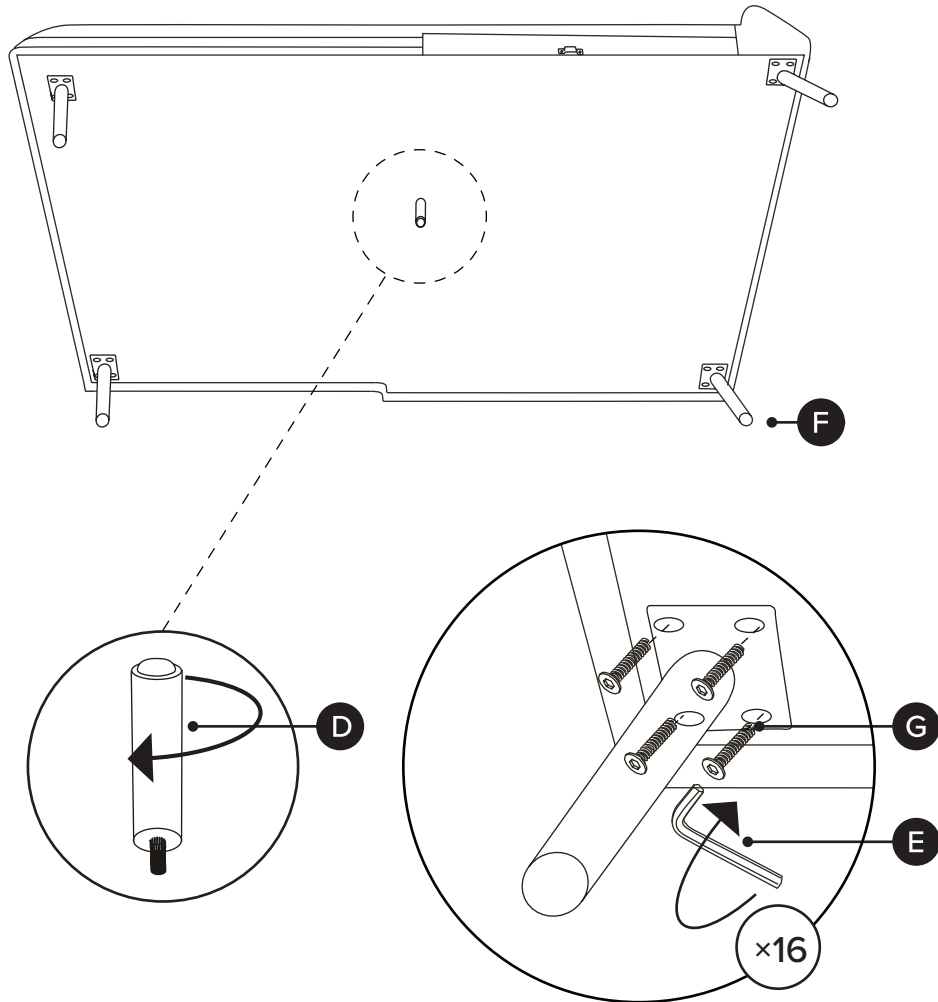

Once bolts are in place flip chaise section (A) upright.

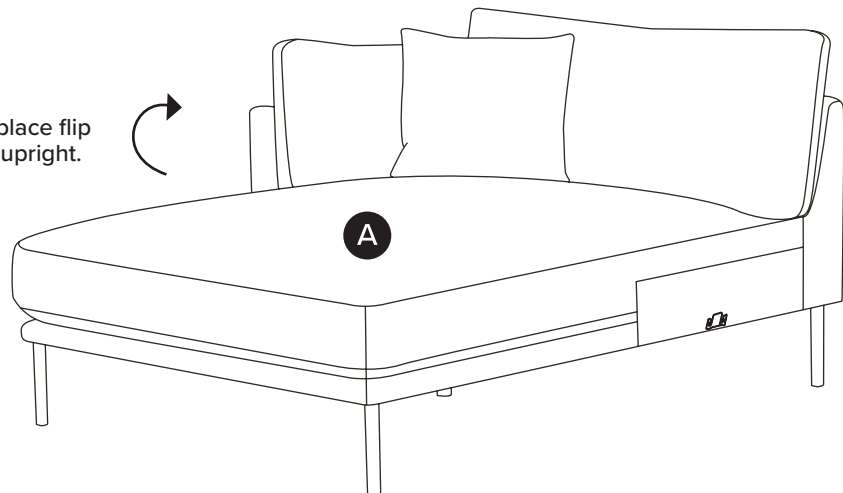

2

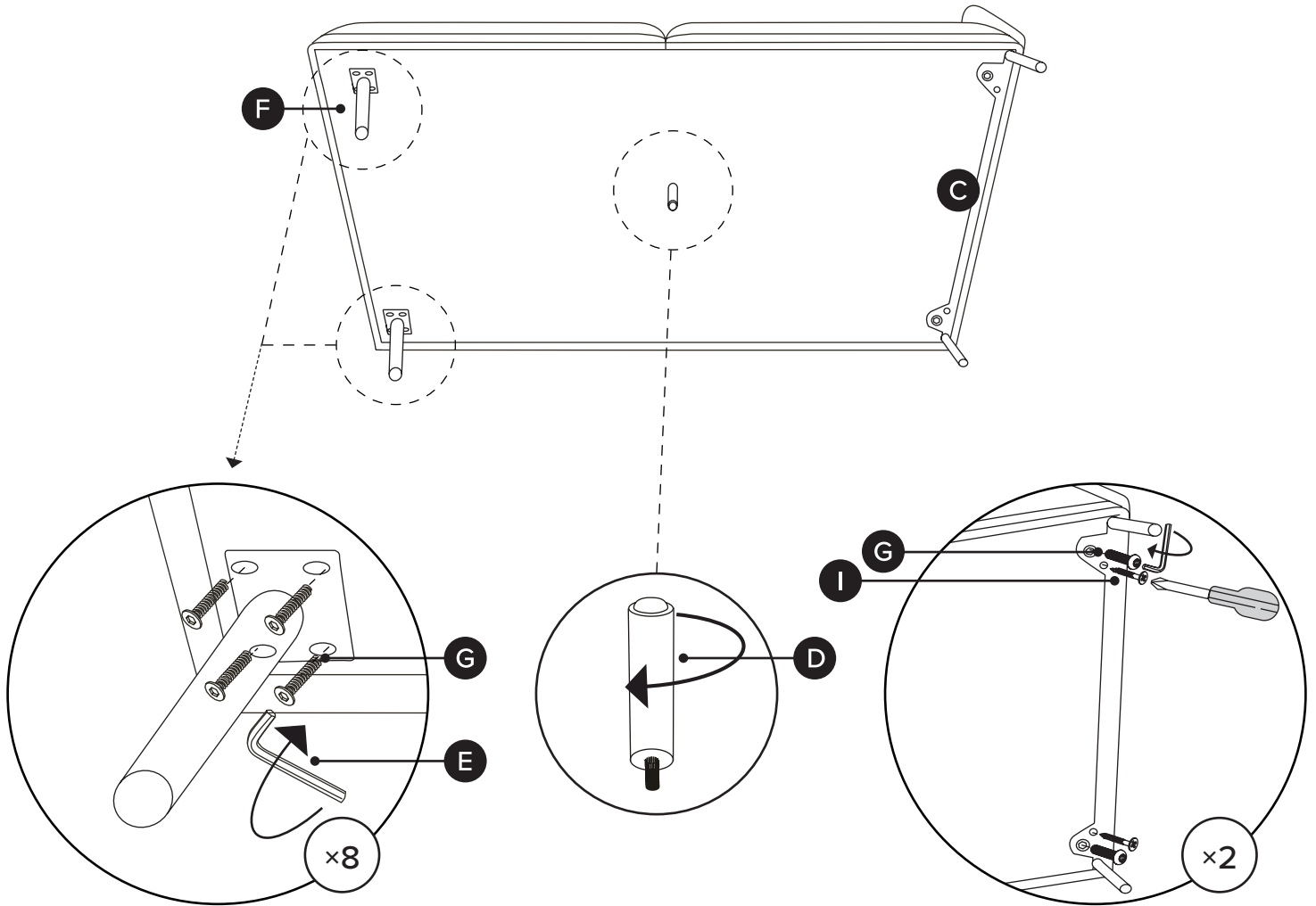

! Once bolts are in place flip sofa section (B) upright.

