

# ARTICLE.

VERSION 1.1

## Assembly Instructions

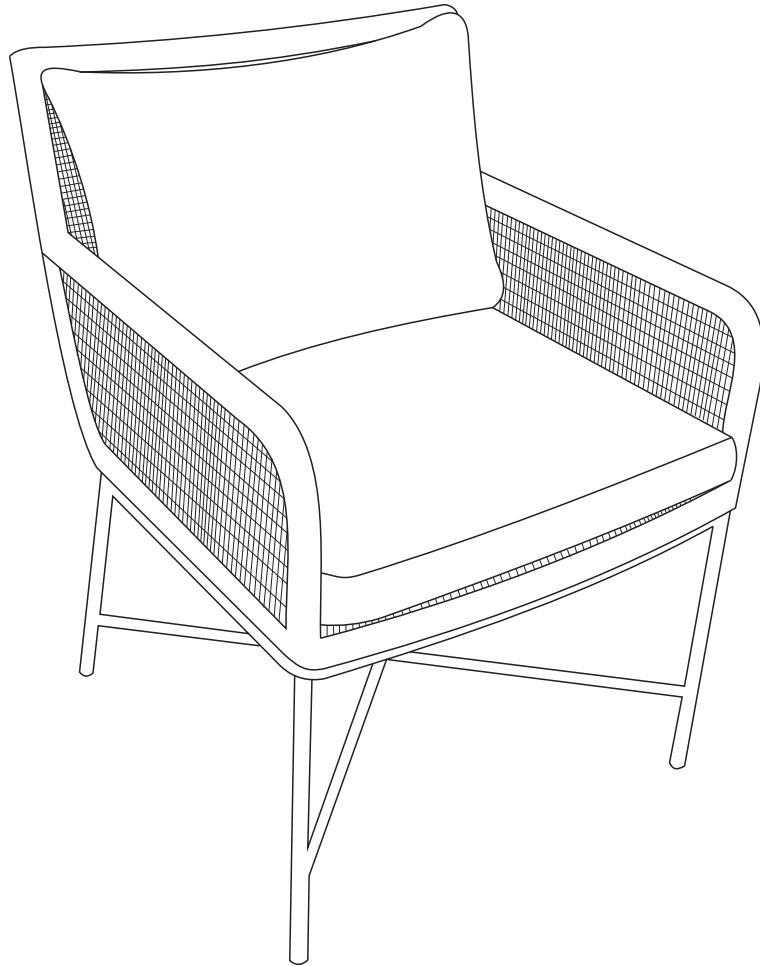

# TODY

Dining Chair

## ASSEMBLY INSTRUCTIONS

Read these instructions carefully and keep for future reference. Refer to parts inventory for guidance, and ensure you have all pieces before starting.

When assembling, place all parts on a soft, clean, and flat surface such as a carpet to prevent scratches.

If you're having difficulty, our friendly Customer Care team is always here to help. Call us at **1.888.746.3455** during business hours, email [service@article.com](mailto:service@article.com) or chat live at [article.com](https://www.article.com).

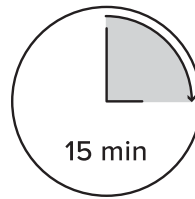

TIME

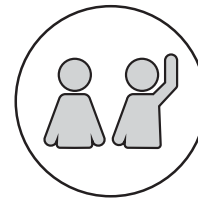

# OF PEOPLE

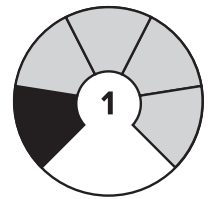





DIFFICULTY



Hardware may loosen over time, check the bolts regularly and tighten if necessary.



DO NOT fully tighten all bolts until assembly is completed.

PARTS INVENTORY		
ID	DESCRIPTION	QTY
<b>A</b>	LEG FRAME	1
<b>B</b>	SEAT FRAME	1
<b>C</b>	M6 LOCK WASHER 	4
<b>D</b>	M6 FLAT WASHER 	4
<b>E</b>	M6 x 30MM BOLT 	4
<b>F</b>	ALLEN KEY 	1
<b>G</b>	SEAT CUSHION	1
<b>H</b>	BACK CUSHION	1

1

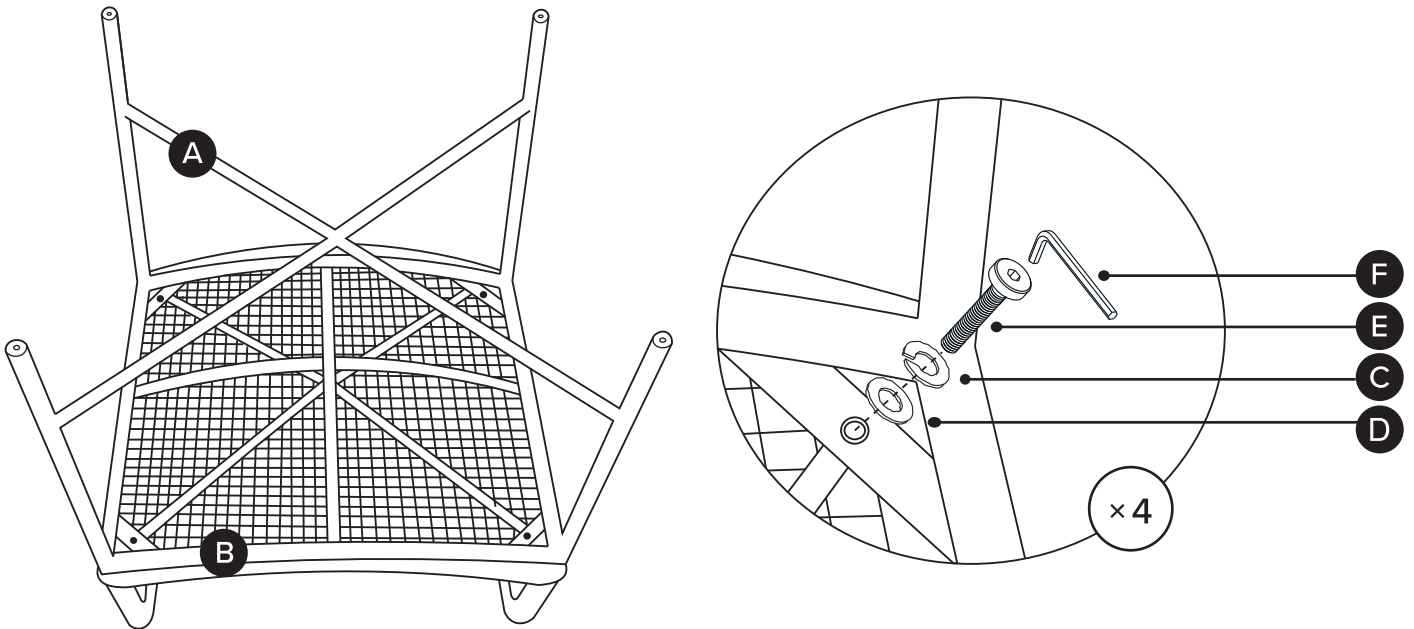

2

