

ARTICLE.

VERSION 1

Assembly Instructions

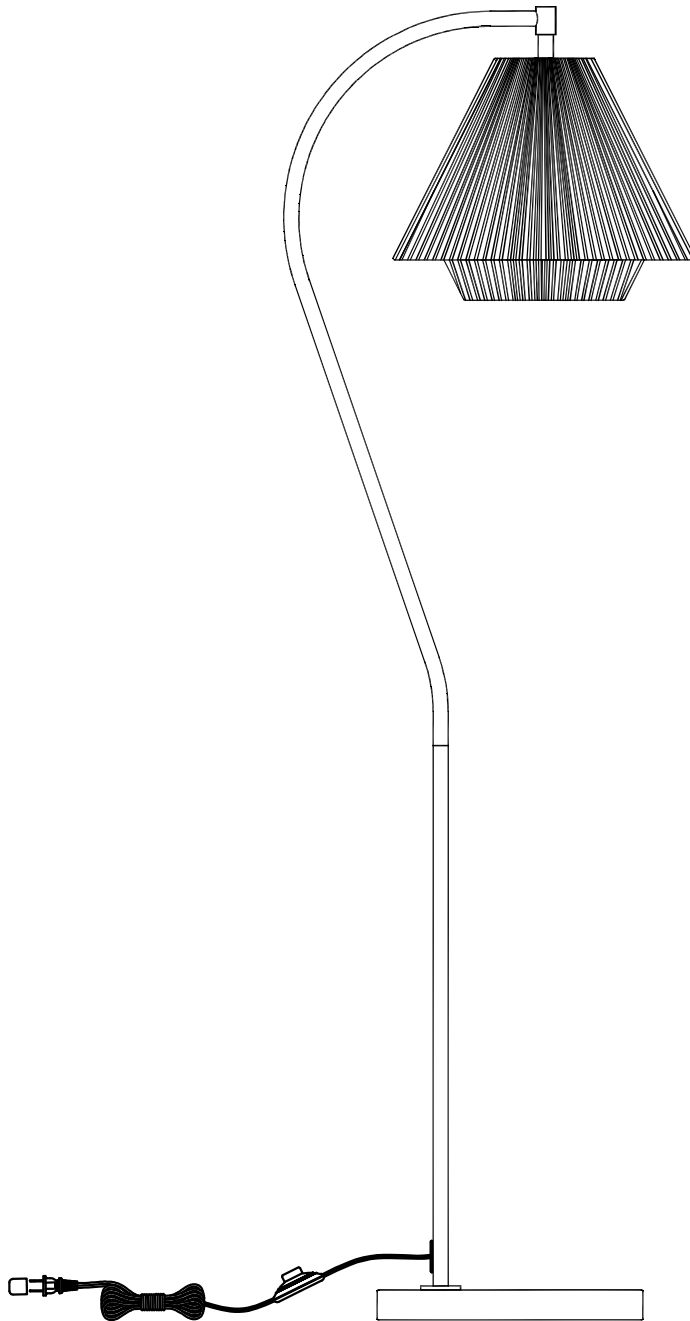

GAVI

Floor Lamp

ASSEMBLY INSTRUCTIONS

Read these instructions carefully and keep for future reference. Refer to parts inventory for guidance, and ensure you have all pieces before starting.

When assembling, place all parts on a soft, clean, and flat surface such as a carpet to prevent scratches.

If you're having difficulty, our friendly Customer Care team is always here to help. Call us at **1.888.746.3455** during business hours, email service@article.com or chat live at [article.com](https://www.article.com).

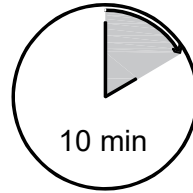

10 min

TIME

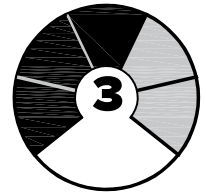



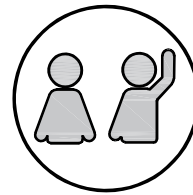

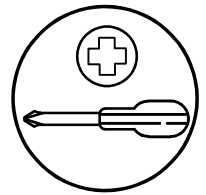

DIFFICULTY





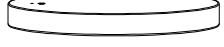



OF PEOPLE



REQUIRED TOOL

PARTS INVENTORY		
ID	DESCRIPTION	QTY
A	LAMP TOP SEGMENT WITH SOCKET 	1
B	LAMP BOTTOM SEGMENT 	1
C	BASE 	1
D	LAMP SHADE 	1
E	SOCKET RING (PRE-INSTALLED) 	1
F	BULB 	1

PARTS INVENTORY CONT.		
ID	DESCRIPTION	QTY
G	SCREWS 8/32x8mm 	2
H	WASHER 20mm 	1
I	FLAT WASHER 39mm 	1
J	NUT 19mm 	1
K	WRENCH 	1
L	FELT PAD 	1

1

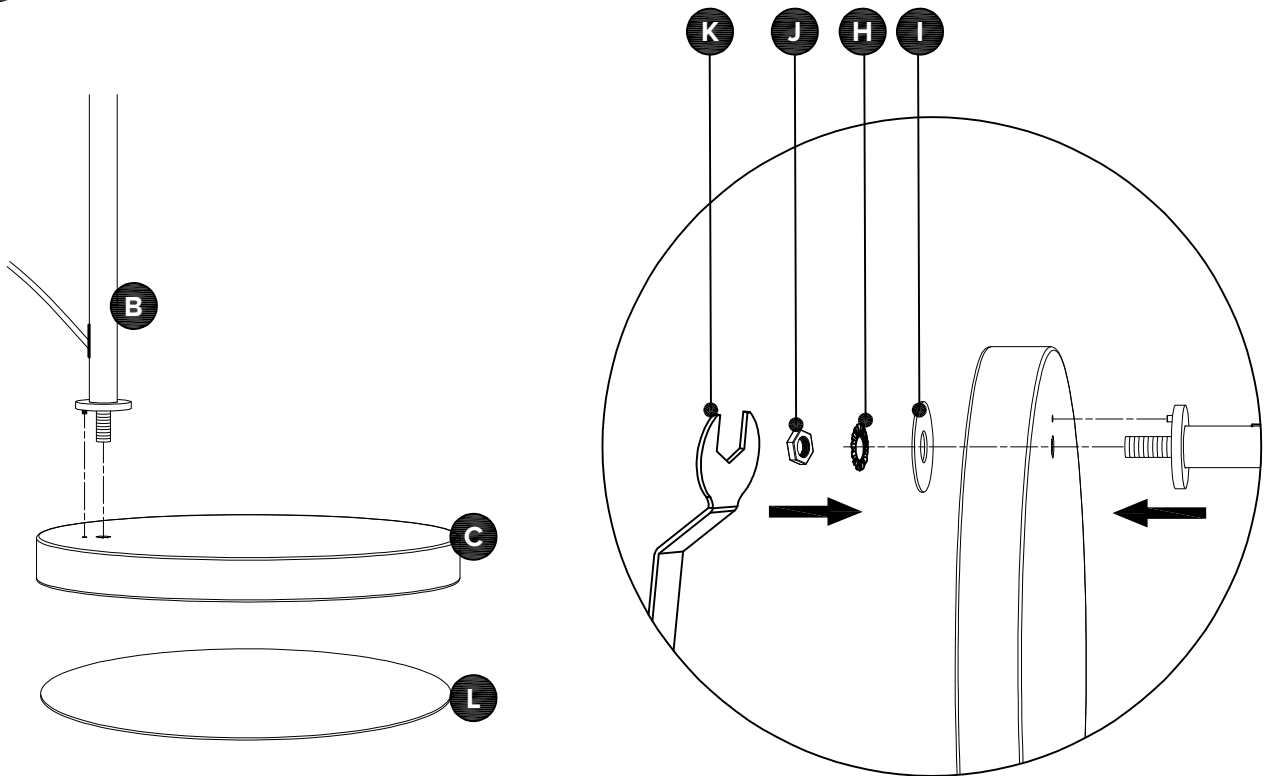

2

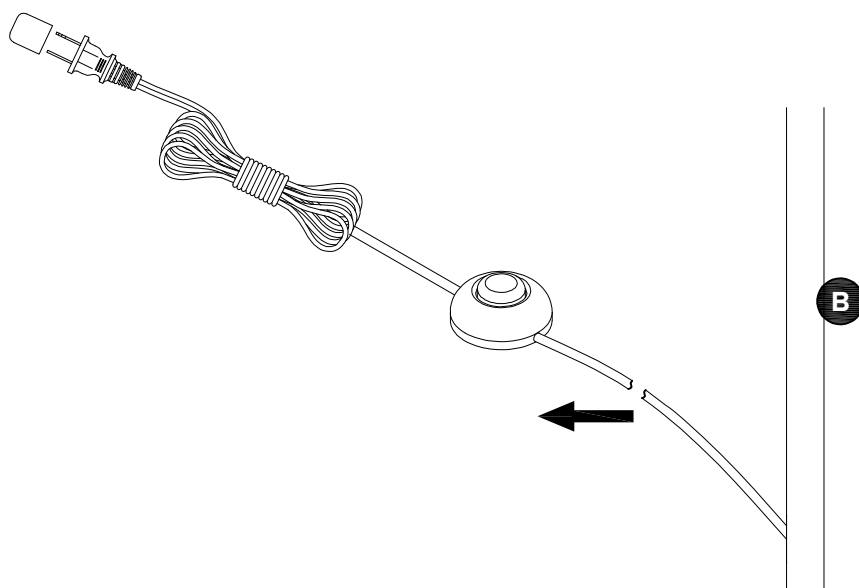

! Pull the cord until segment (A) and (B) are connected.

3

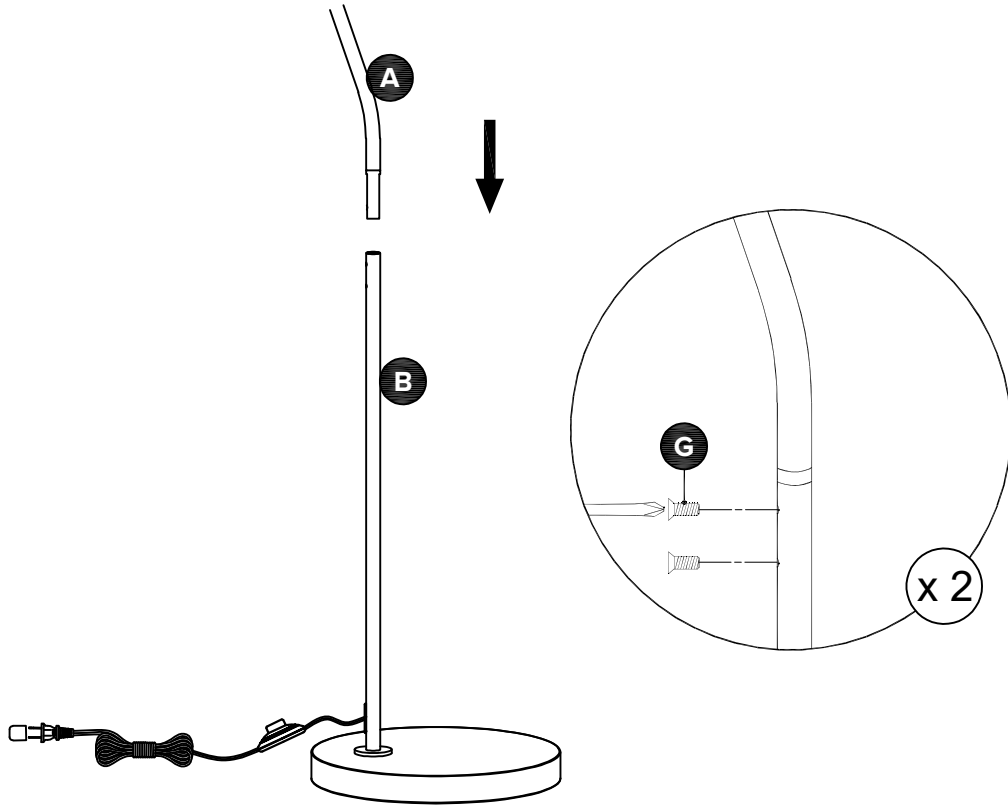

4

