

ARTICLE.

VERSION 1

Assembly Instructions

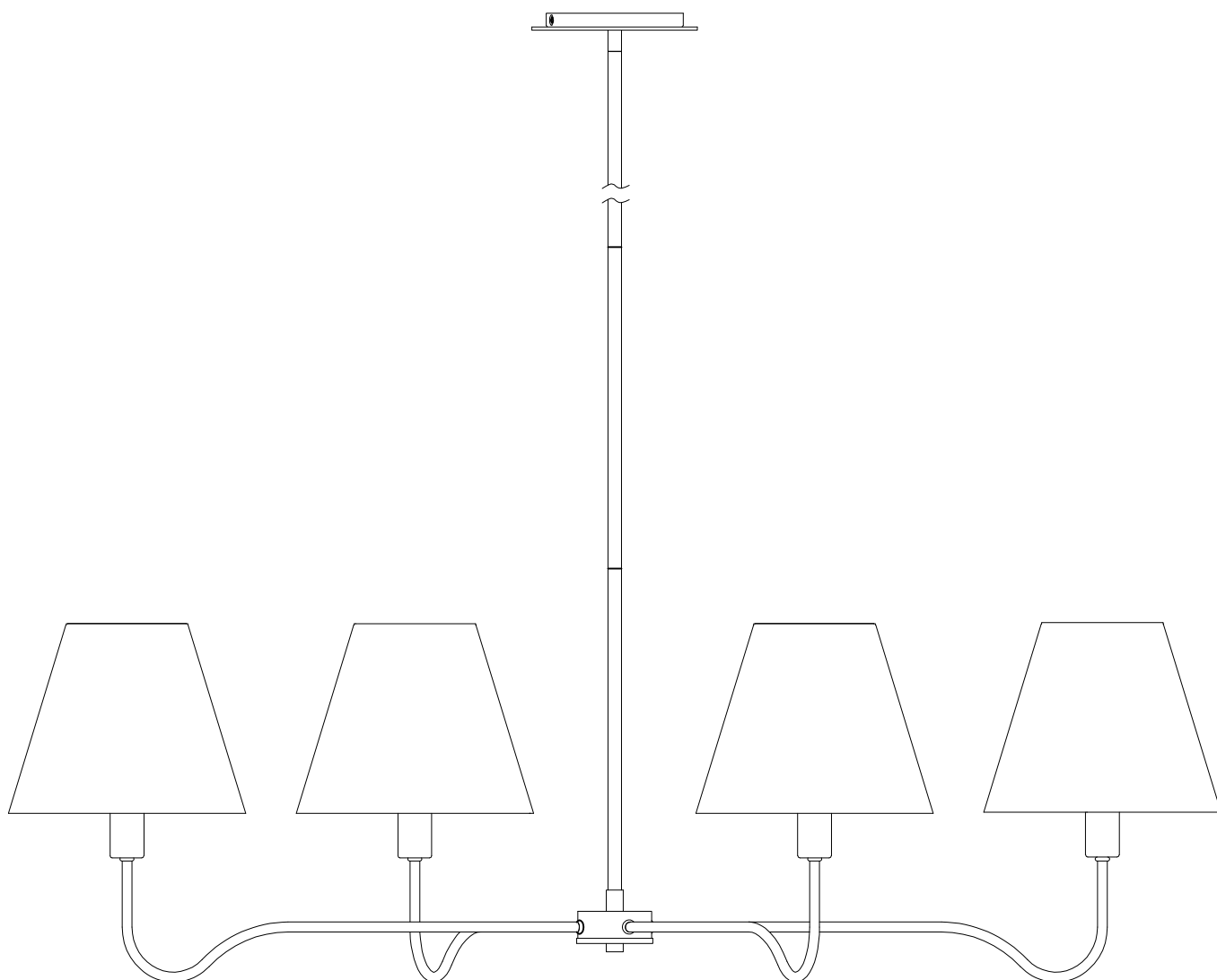

LOMBARD

Chandelier

ASSEMBLY INSTRUCTIONS

Read these instructions carefully and keep for future reference. Refer to parts inventory for guidance, and ensure you have all pieces before starting.

When assembling, place all parts on a soft, clean, and flat surface such as a carpet to prevent scratches.

If you're having difficulty, our friendly Customer Care team is always here to help. Call us at **1.888.746.3455** during business hours, email **service@article.com** or chat live at **article.com**.

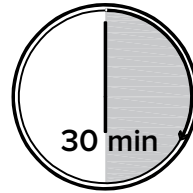

TIME



DIFFICULTY

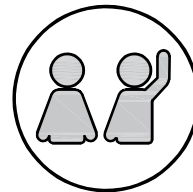



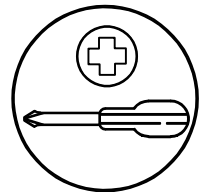



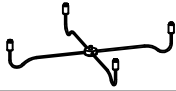

OF PEOPLE

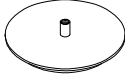

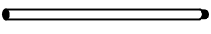
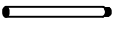
REQUIRED TOOL

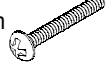
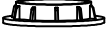
! Consultation with a professional electrician is recommended for the installation of this chandelier.

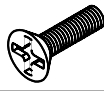
PARTS INVENTORY			
ID	DESCRIPTION		QTY
A	LAMP BODY WITH SOCKETS		1
B	SHADE		4
C	CANOPY		1
D	MOUNTING BRACKET IRON ROUND		1
E	METAL TUBES 12 INCH		3
F	METAL TUBE 6 INCH		1
G	SHORT GREEN SCREW 8/32x8mm		1
H	WIRE NUT		3
I	MOUNTING SCREWS 8/32x25mm		2
J	SOCKET RING (PRE-INSTALLED)		4

PARTS INVENTORY CONT.			
ID	DESCRIPTION		QTY
K	SIDE SCREW 8/32x20mm		2
L	BULB E12		4

1

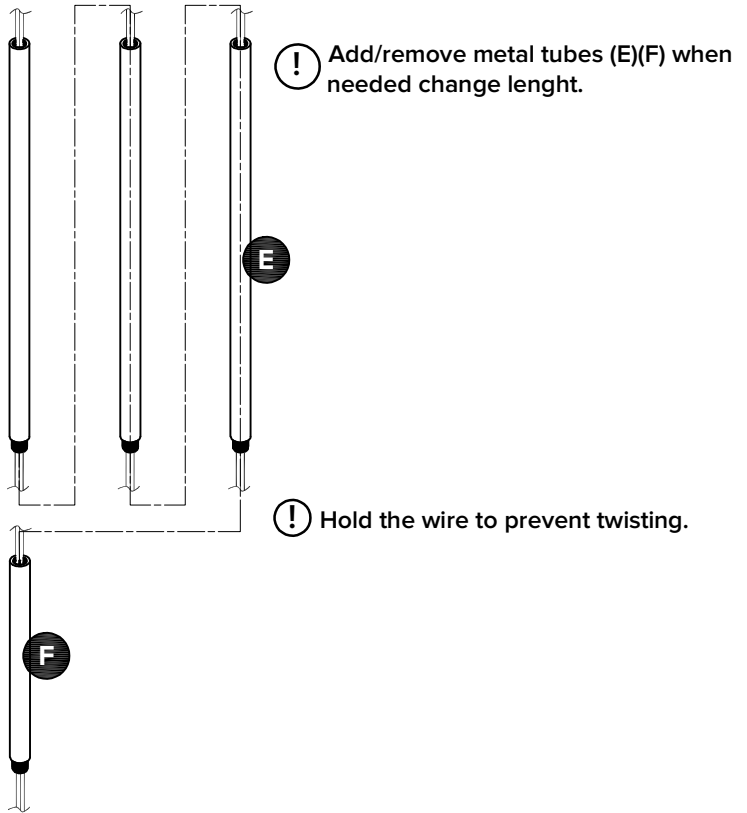

2

! Insert wire per metal tube from this side

CAUTION
Turn off power at main circuit pannel
before starting installation.

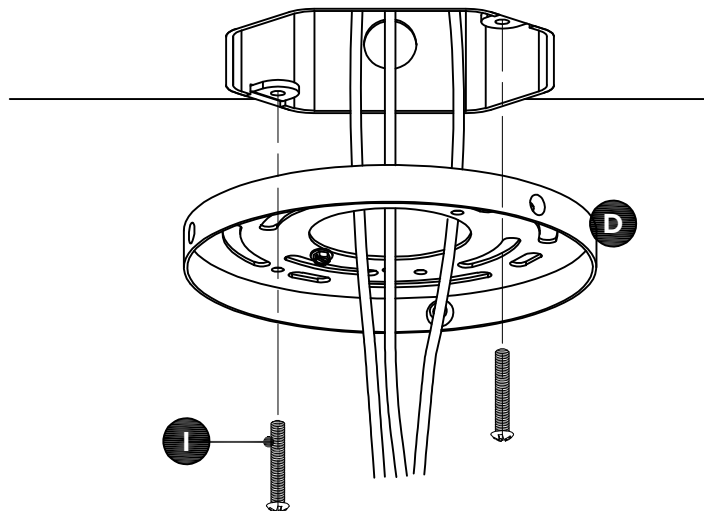

! Thread wires through mounting bracket iron round (D) before attaching to junction box.

3

! Match up wires by color and attach with wire nuts (H).

BLACK: Hot Fixture

WHITE: Neutral Fixture

GREEN OR BARE COPPER: Ground wire

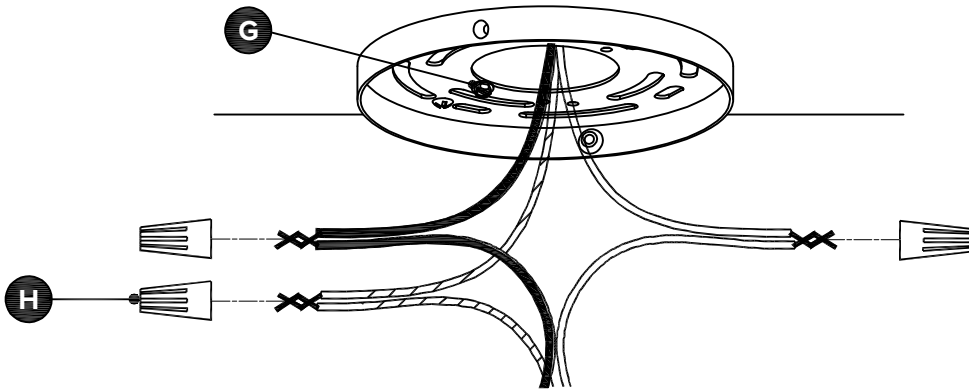

! If junction box does not have a green ground wire, attach ground wire from lamp to short green screw (G) on mounting bracket.

4

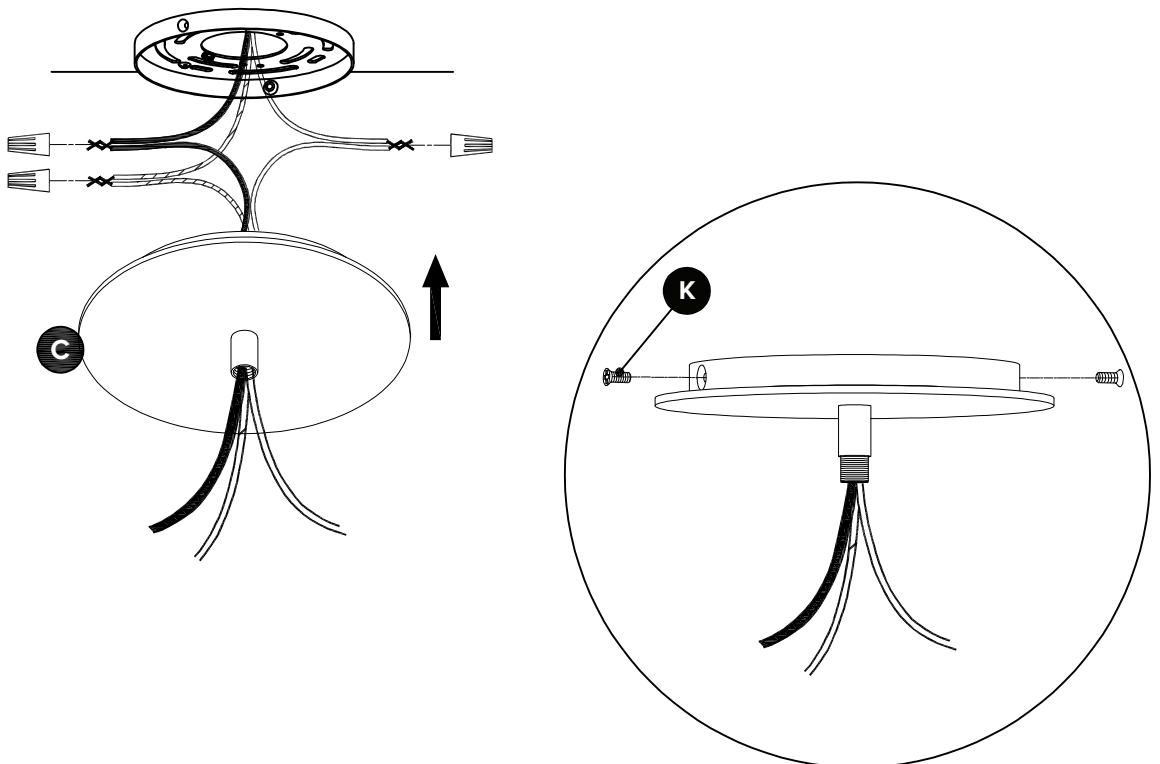

5

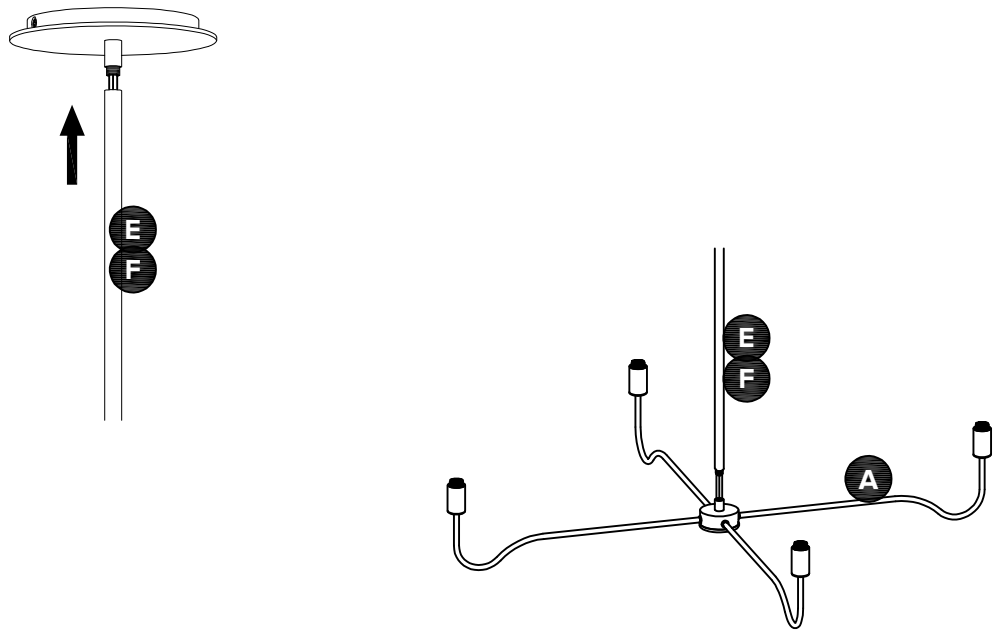

6

