

ARTICLE.

VERSION 1.0

Assembly Instructions

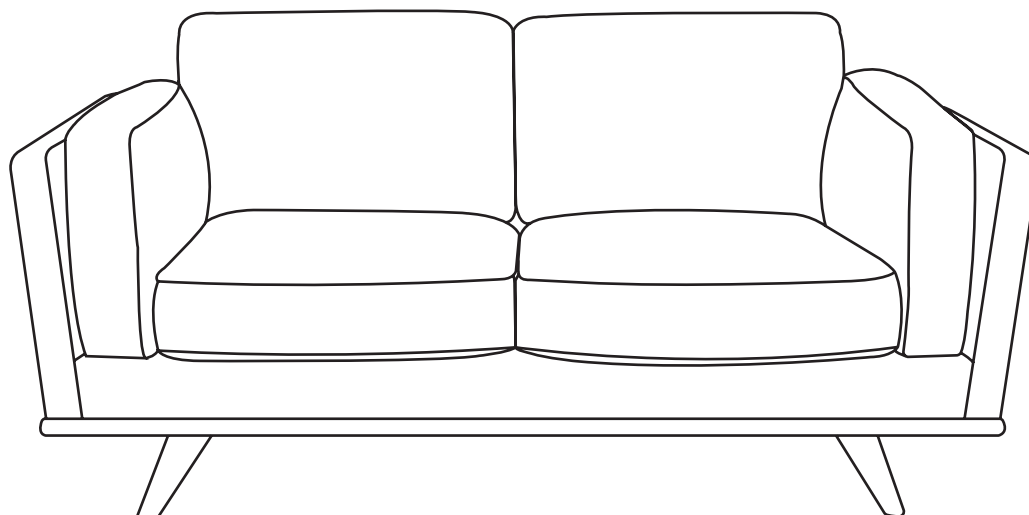

TIMBER

Loveseat

ASSEMBLY INSTRUCTIONS

Read these instructions carefully and keep for future reference. Refer to parts inventory for guidance, and ensure you have all pieces before starting.

When assembling, place all parts on a soft, clean, and flat surface such as a carpet to prevent scratches.

If you're having difficulty, our friendly Customer Care team is always here to help. Call us at **1.888.746.3455** during business hours, email service@article.com or chat live at [article.com](https://www.article.com).

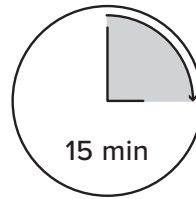

15 min



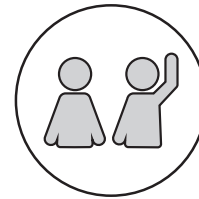

TIME

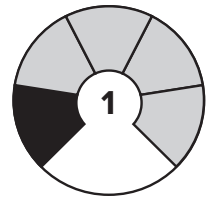



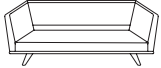
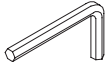

OF PEOPLE



DIFFICULTY

PARTS INVENTORY			
ID	DESCRIPTION		QTY
A	SOFA		1
B	ALLEN KEY		1
C	M10 x 60MM BOLT		4
D	LOCK WASHER		4
E	WASHER		4

PARTS INVENTORY CONT.			
ID	DESCRIPTION		QTY
F	LEG		4
G	ARM CUSHION		2
H	SEAT CUSHION		2
I	BACK CUSHION		2

1

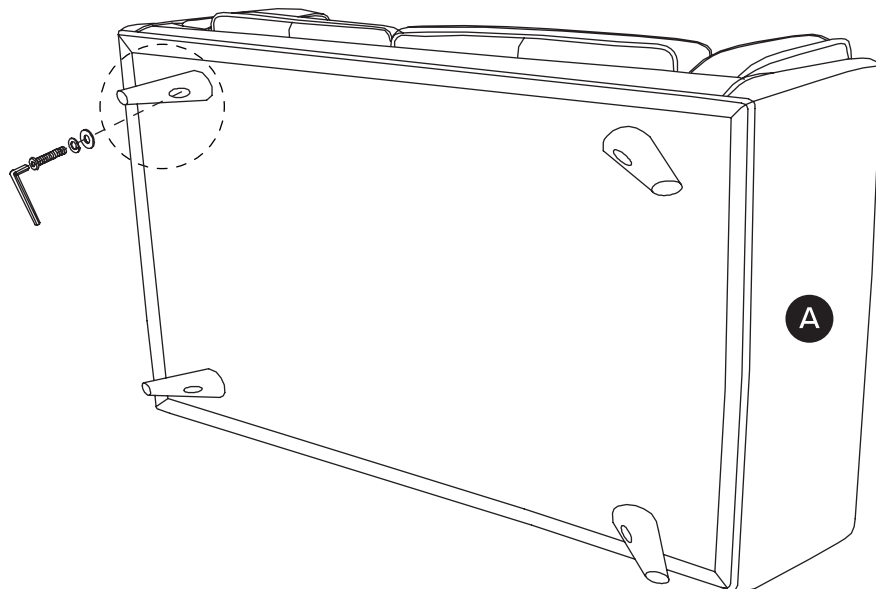
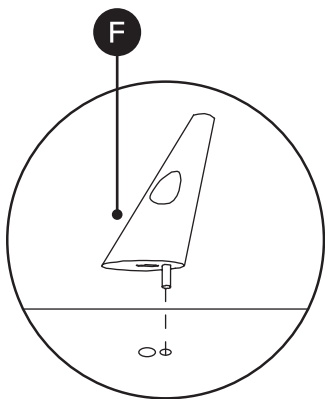

! Align dowels and insert legs (F) into sofa first.

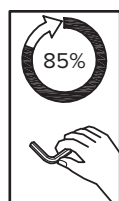
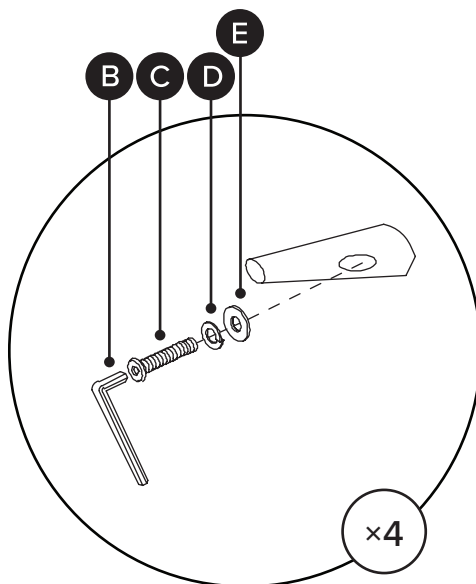

! Insert bolt (C) and washers (D/E) through hole on legs (F). Do not fully tighten right away.

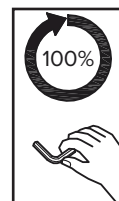

! Check leg angles are all correct before fully tightening. After bolts are fully tightened ensure leg stability before moving sofa.

2

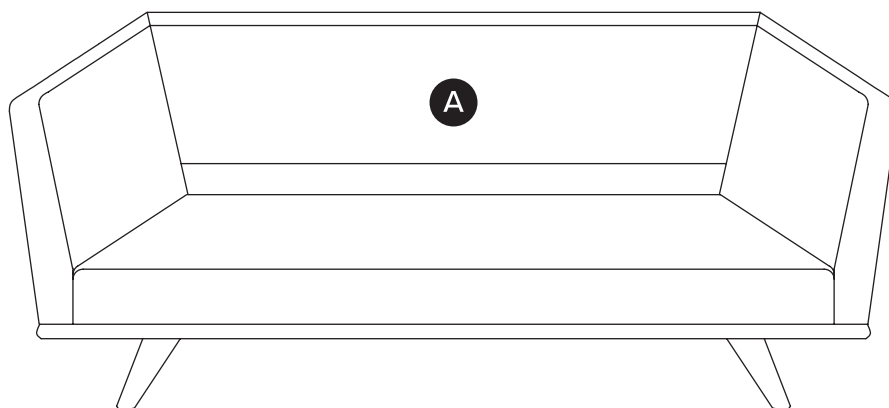

3

! Slanted sides of arm cushions (G) fit to the back of the sofa.

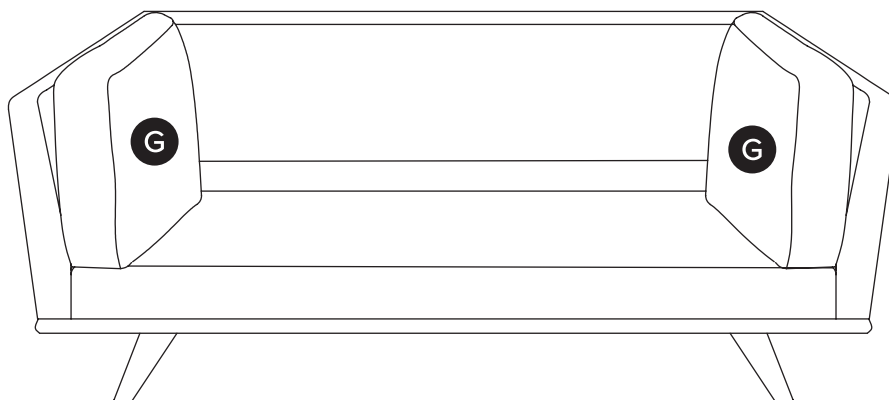

4

! Place seat cushions (H)
fit to the back of the sofa.

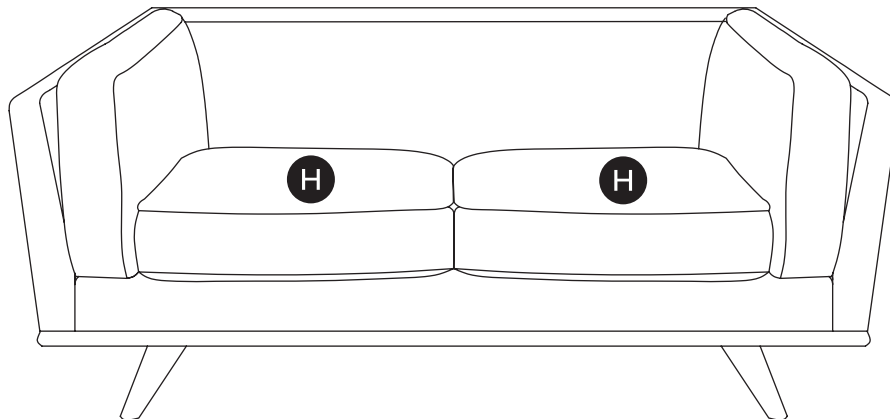

5

! Place back cushions (I)
fit to the back of the sofa.

