

ARTICLE.

VERSION 1.1

Assembly Instructions

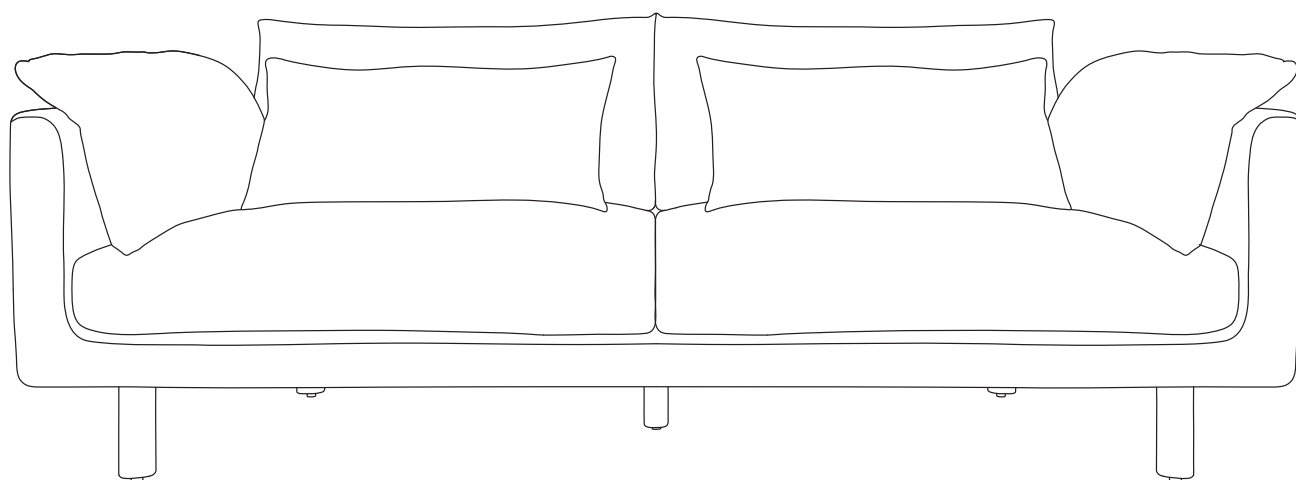

LEO

Sofa

ASSEMBLY INSTRUCTIONS

Read these instructions carefully and keep for future reference. Refer to parts inventory for guidance, and ensure you have all pieces before starting.

When assembling, place all parts on a soft, clean, and flat surface such as a carpet to prevent scratches.

If you're having difficulty, our friendly Customer Care team is always here to help. Call us at **1.888.746.3455** during business hours, email service@article.com or chat live at [article.com](https://www.article.com).

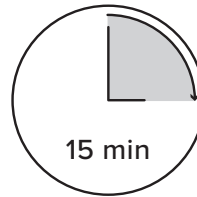

15 min

TIME

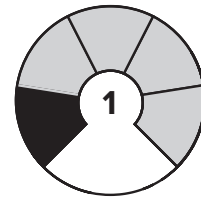

1





DIFFICULTY

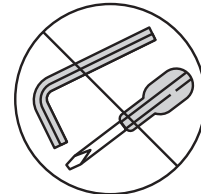

OF PEOPLE

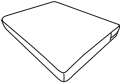
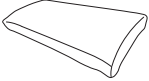

TOOL FREE

PARTS LIST		
ID	DESCRIPTION	QTY
A	SOFA	1
B	SIDE LEG 	4
C	CENTER LEG 	1
D	PLASTIC WASHER 	5
E	SEAT CUSHION 	2
F	BACK CUSHION 	2
G	ARM CUSHION 	2
H	LUMBAR CUSHION 	2

1

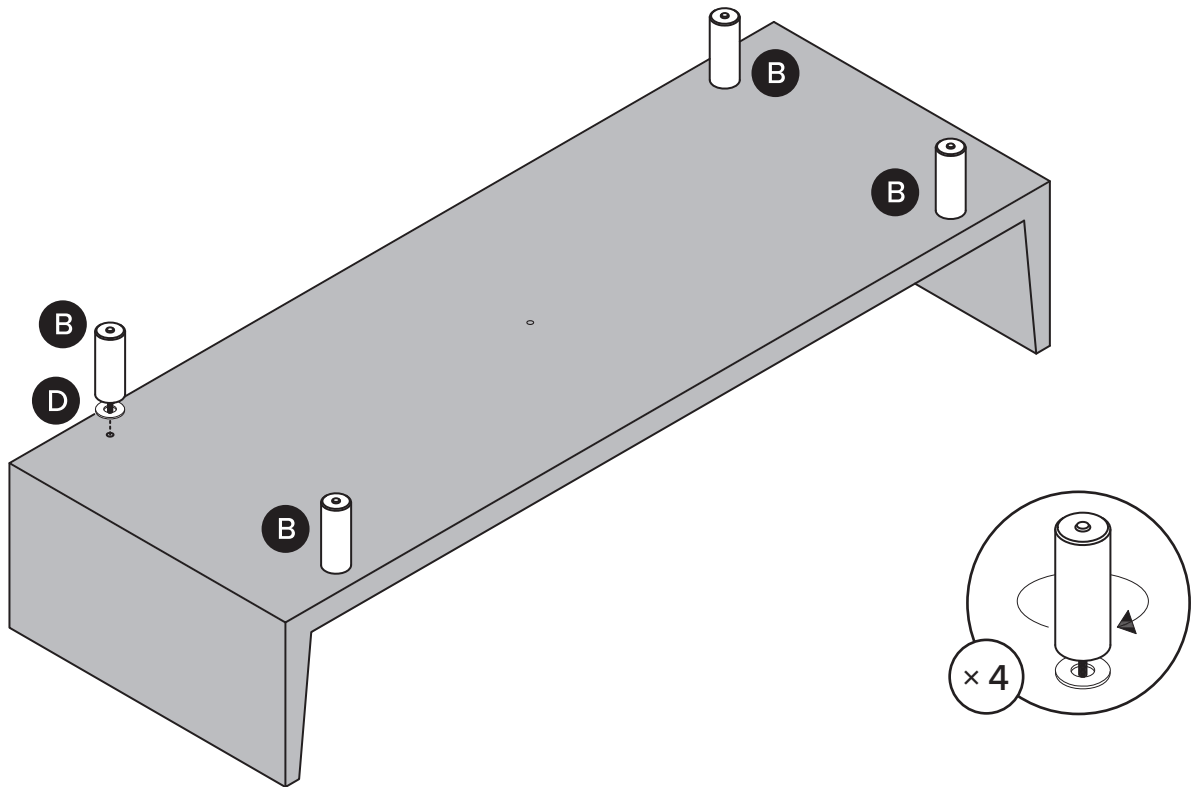

2

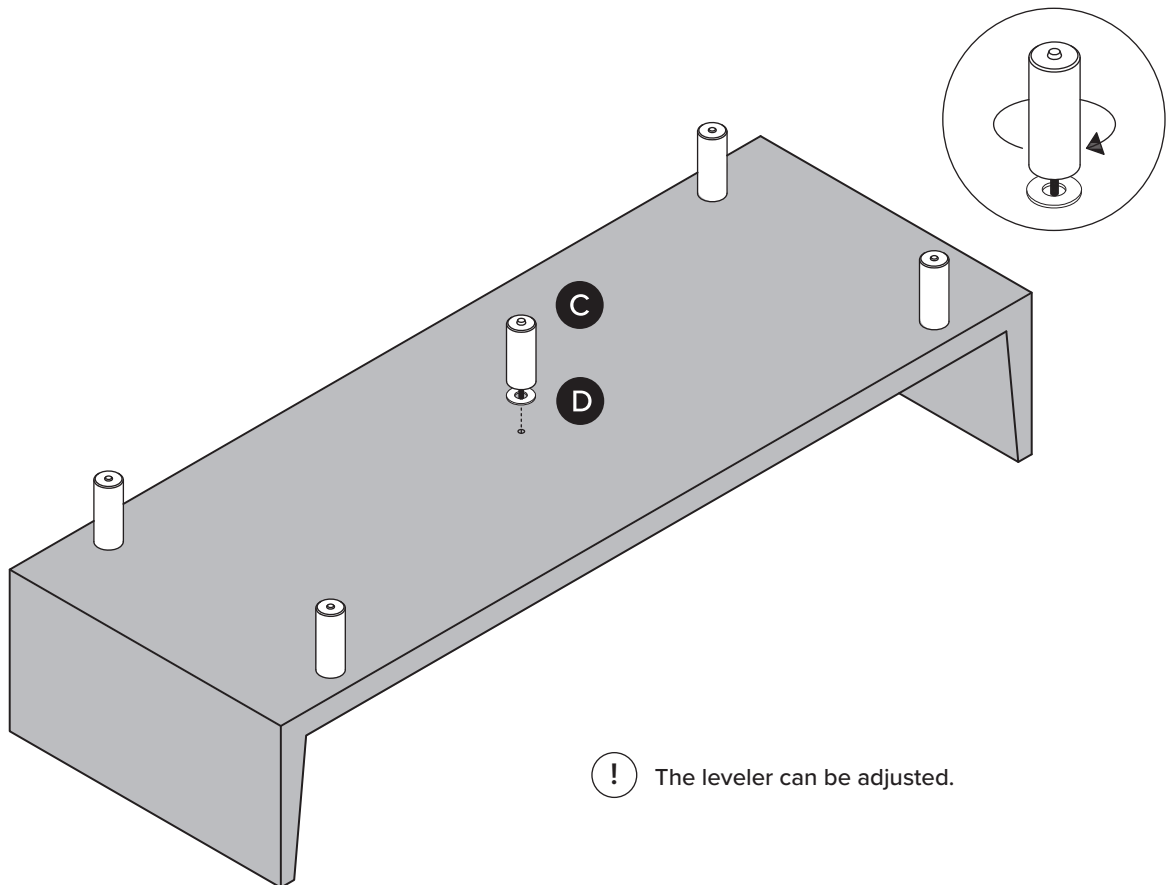

! The leveler can be adjusted.

3

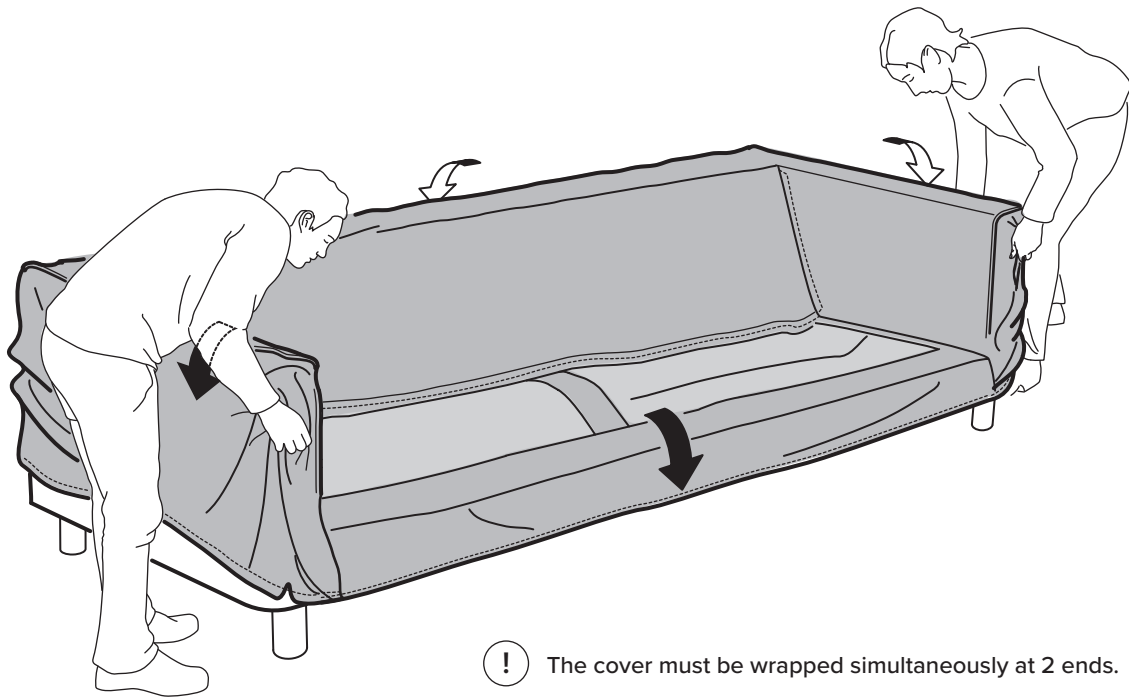

! The cover must be wrapped simultaneously at 2 ends.

4

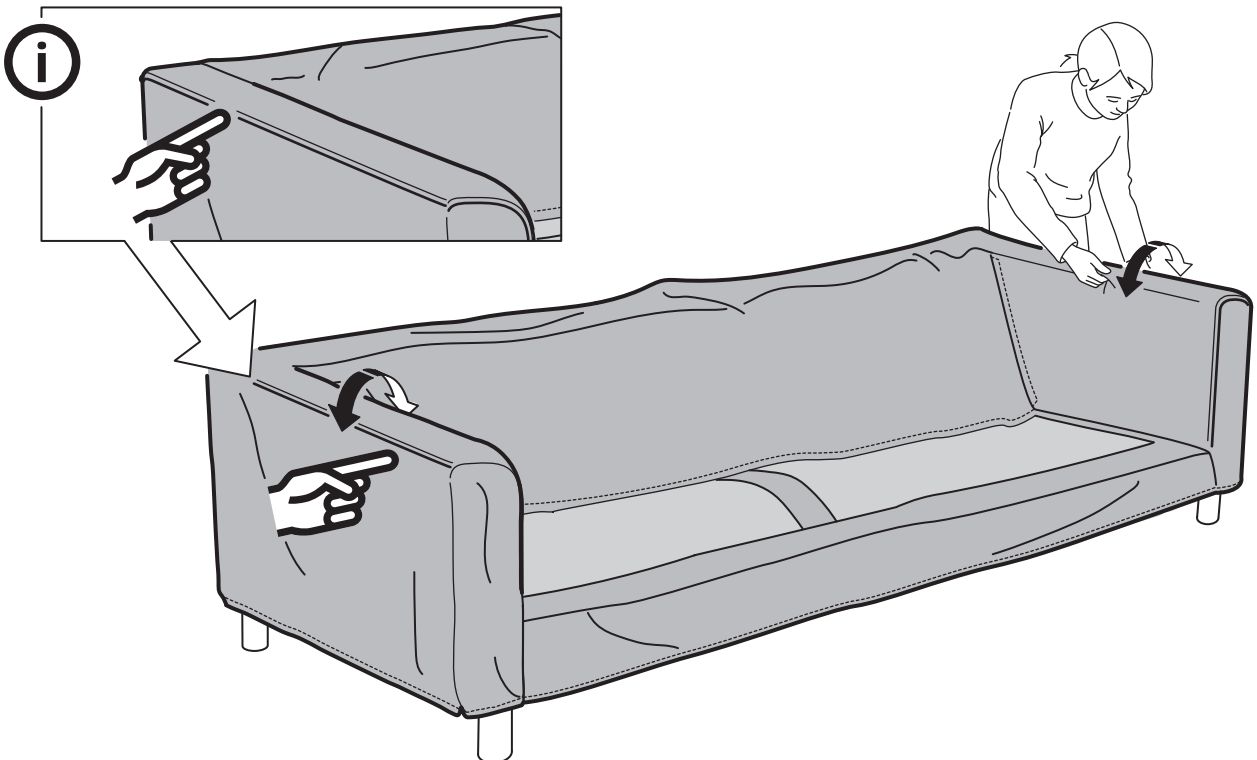

5

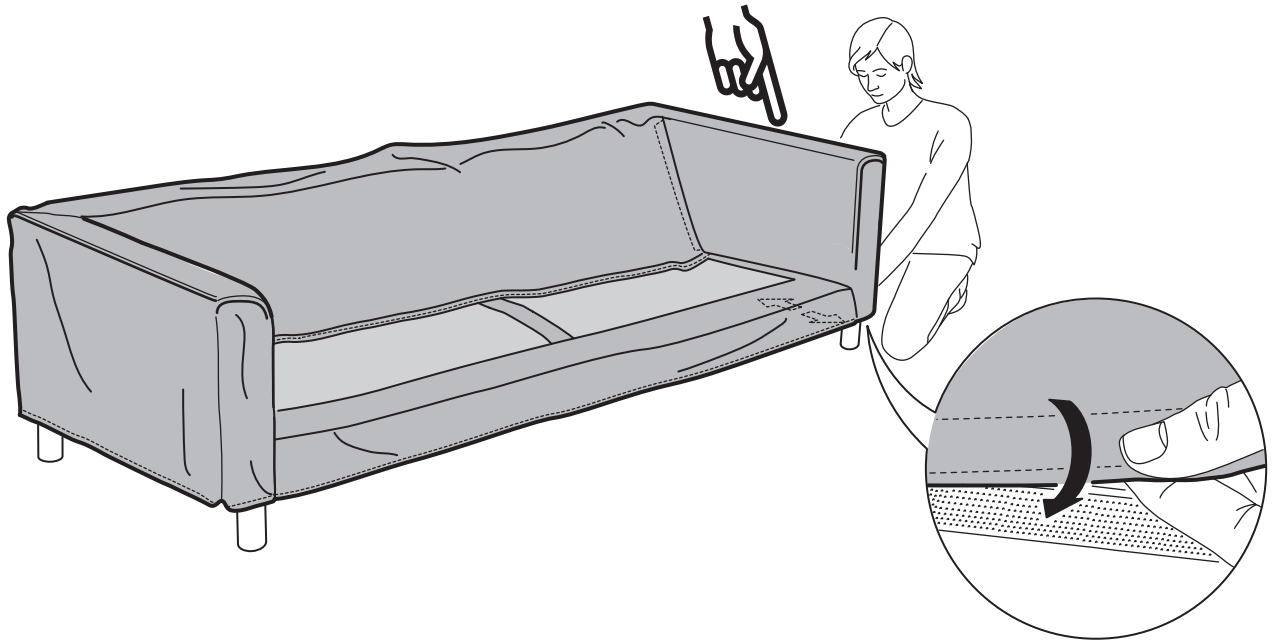

6

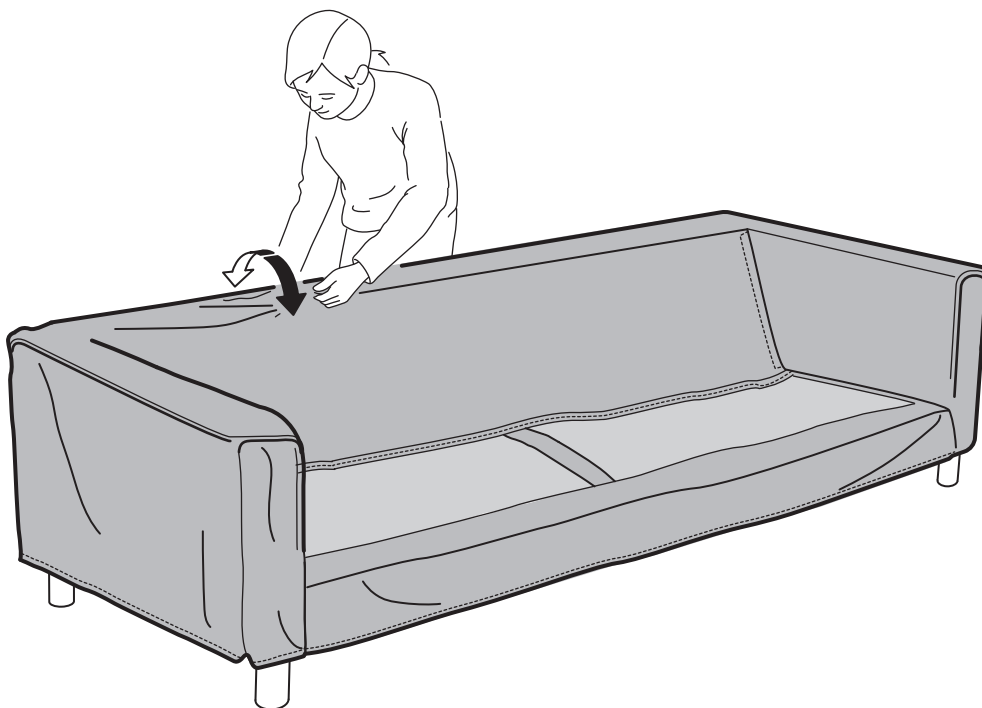

7

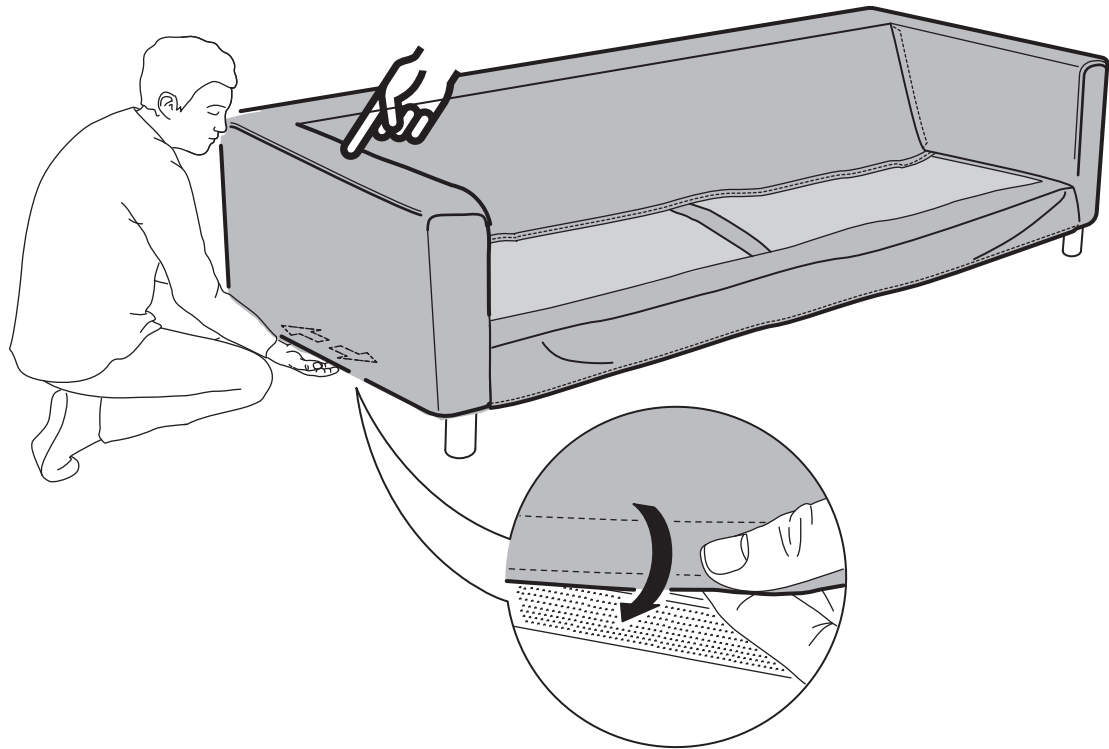

8

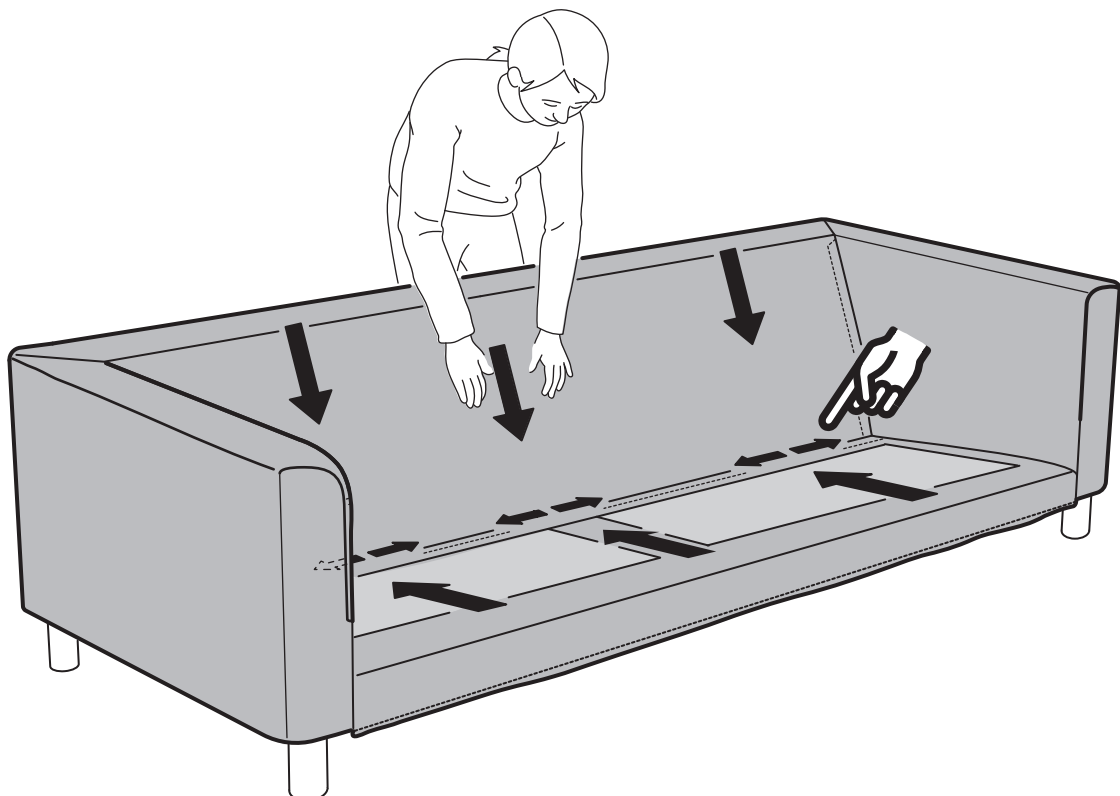

9

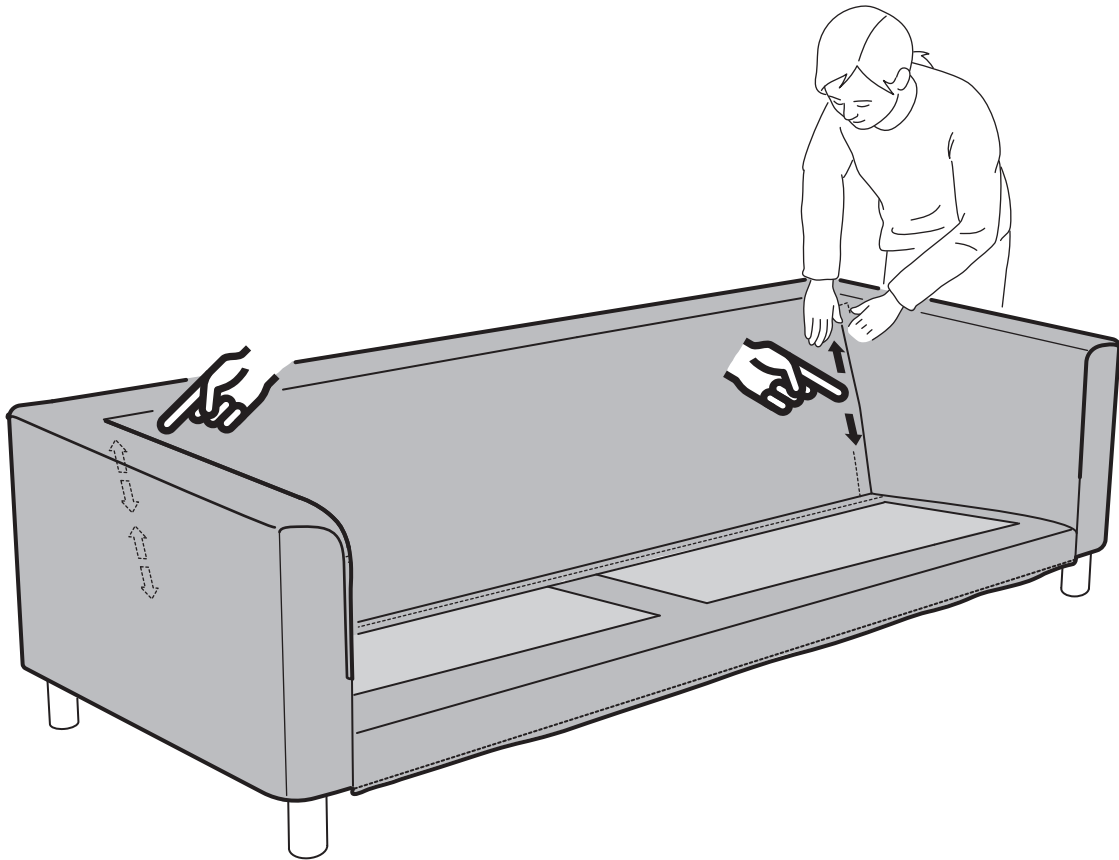

10

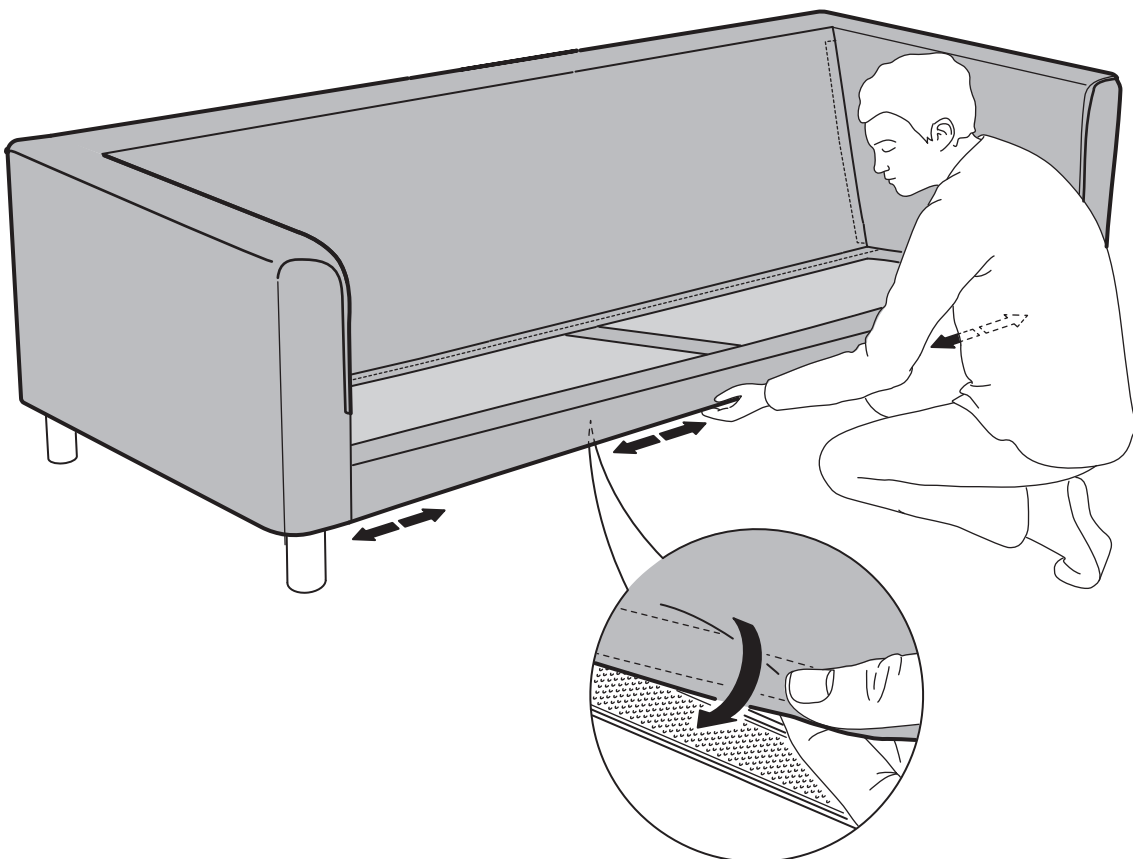

11

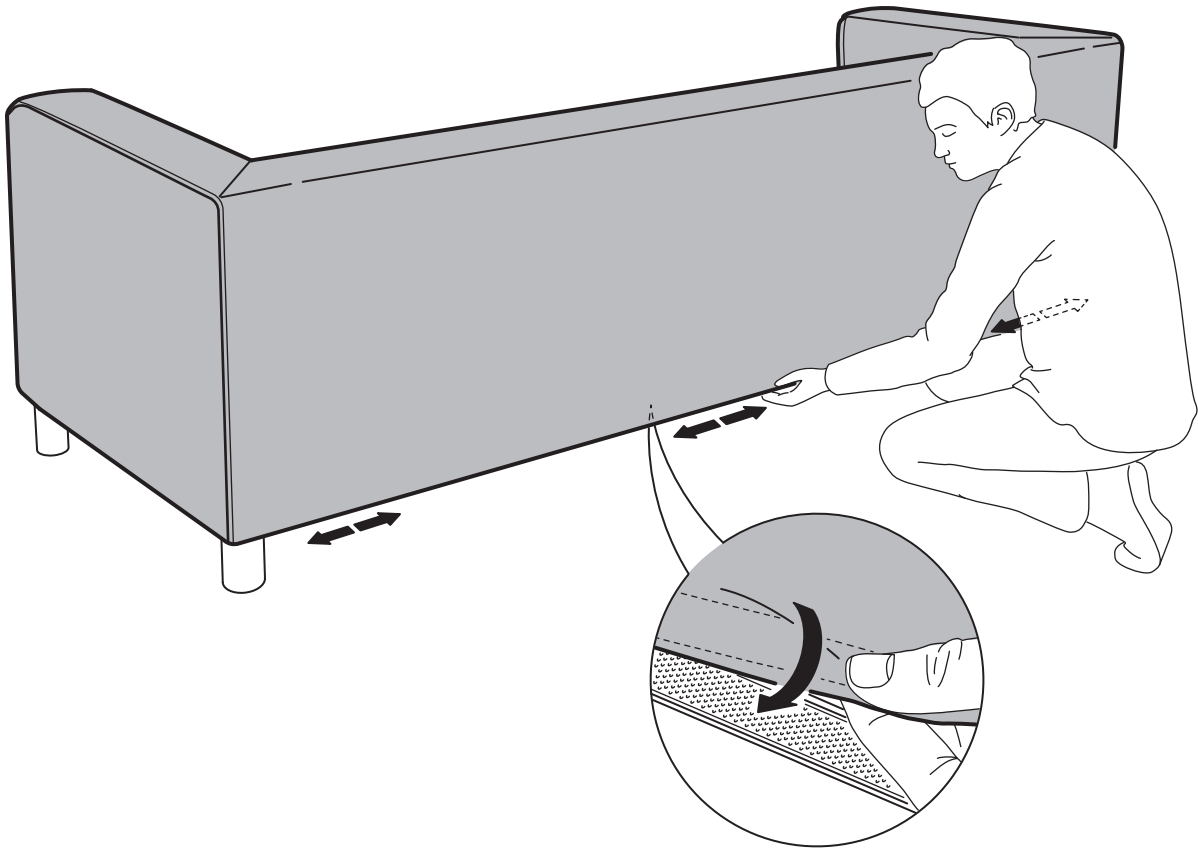

12

