

# ARTICLE.

VERSION 1.1

## Assembly Instructions

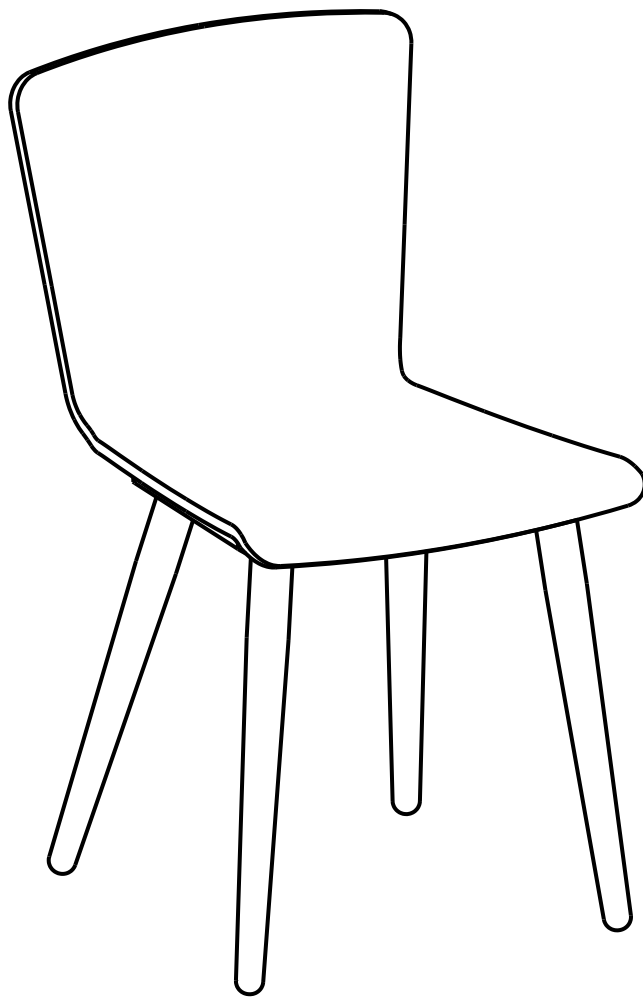

# SEDE

Dining Chair

## ASSEMBLY INSTRUCTIONS

Read these instructions carefully and keep for future reference. Refer to parts inventory for guidance, and ensure you have all pieces before starting.

When assembling, place all parts on a soft, clean, and flat surface such as a carpet to prevent scratches.

If you're having difficulty, our friendly Customer Care team is always here to help. Call us at **1.888.746.3455** during business hours, email [service@article.com](mailto:service@article.com) or chat live at [article.com](https://www.article.com)

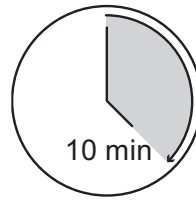



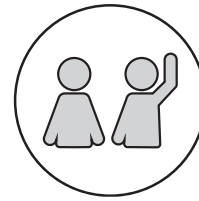

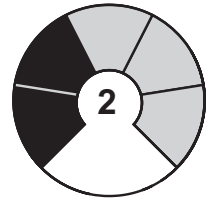

TIME



# OF PEOPLE

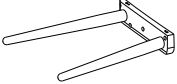
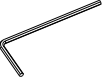

DIFFICULTY

PARTS INVENTORY		
ID	DESCRIPTION	QTY
<b>A</b>	CHAIR SEAT 	1
<b>B</b>	CHAIR LEG LEFT 	1
<b>C</b>	CHAIR LEG RIGHT 	1
<b>D</b>	ALLEN KEY 	1
<b>E</b>	M6 × 25MM BOLT 	10
<b>F</b>	M6 × 10MM LOCK WASHER 	10
<b>G</b>	M6 × 12MM FLAT WASHER 	10

1

Use your hand to attach the Bolt (E) and Washers (F) and (G) when assembly the Left leg (B) and Right Leg (C) on the Seat (A)

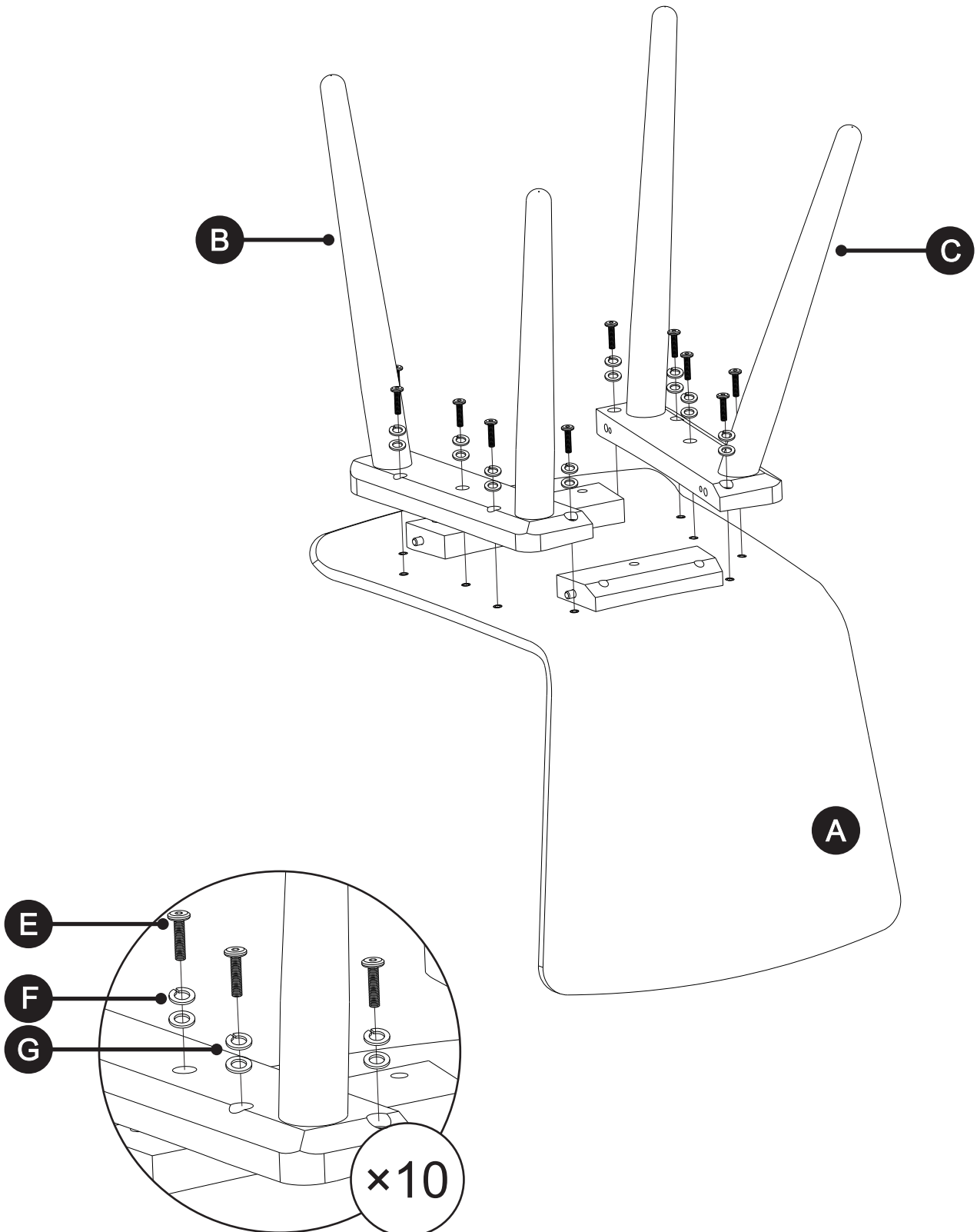

2

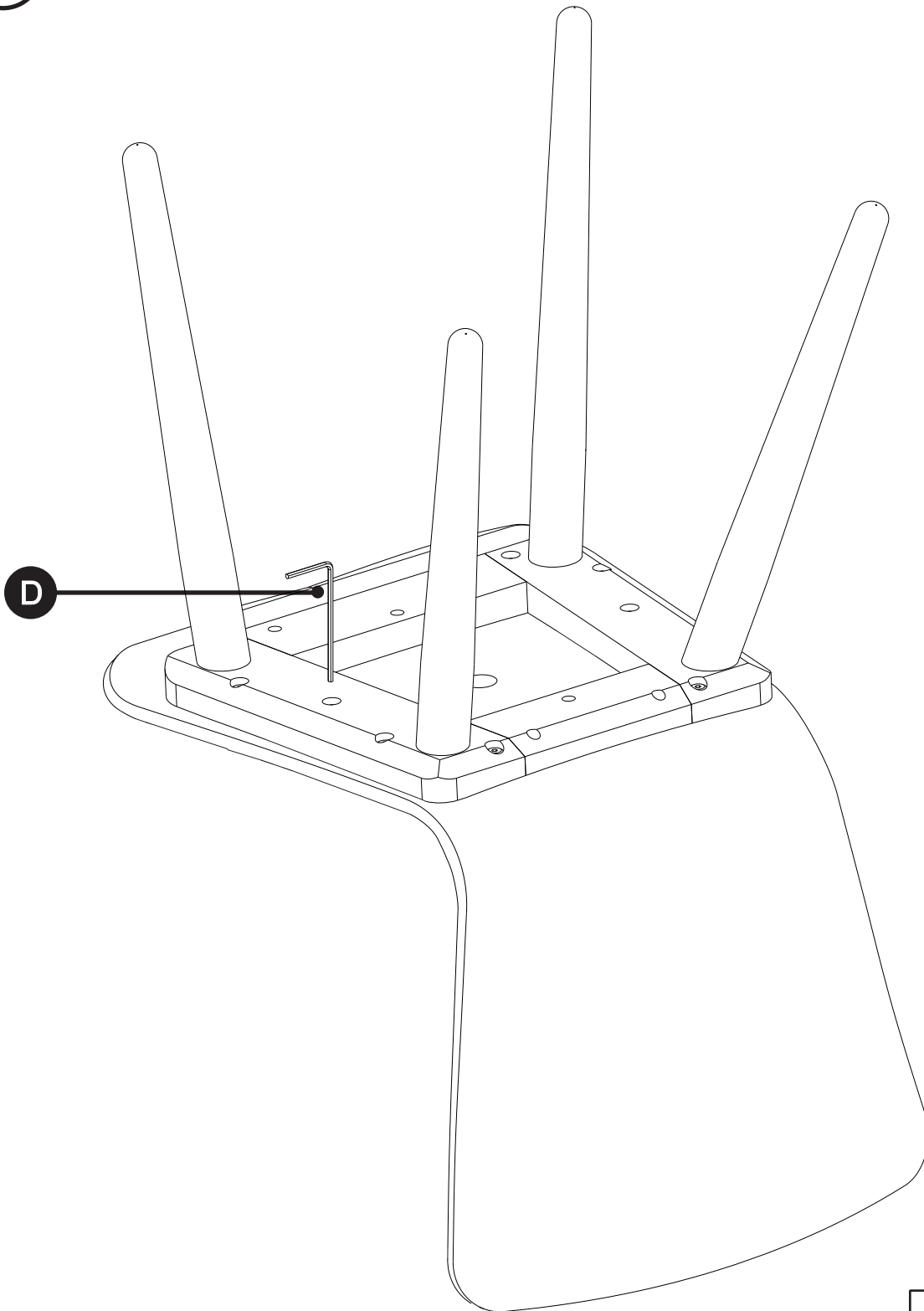

 Use Allen Key (D) to tighten the Bolts (E) to 80%

### 3 LEG STABILITY

---

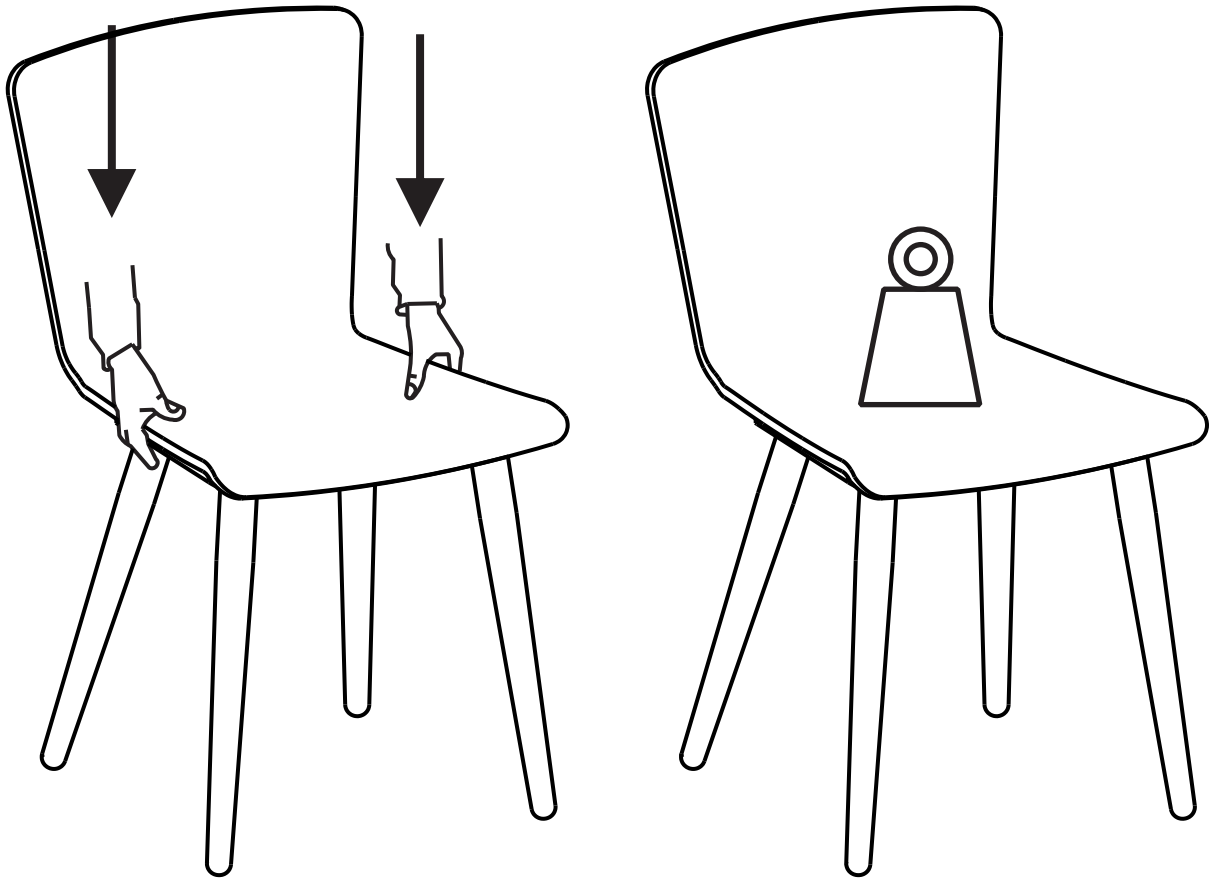

---

⚠ To ensure all 4 legs are flat with the floor please place a weight on the seat or manually push downwards until the 4 legs are flat with the floor before tighten all screws 100%

4

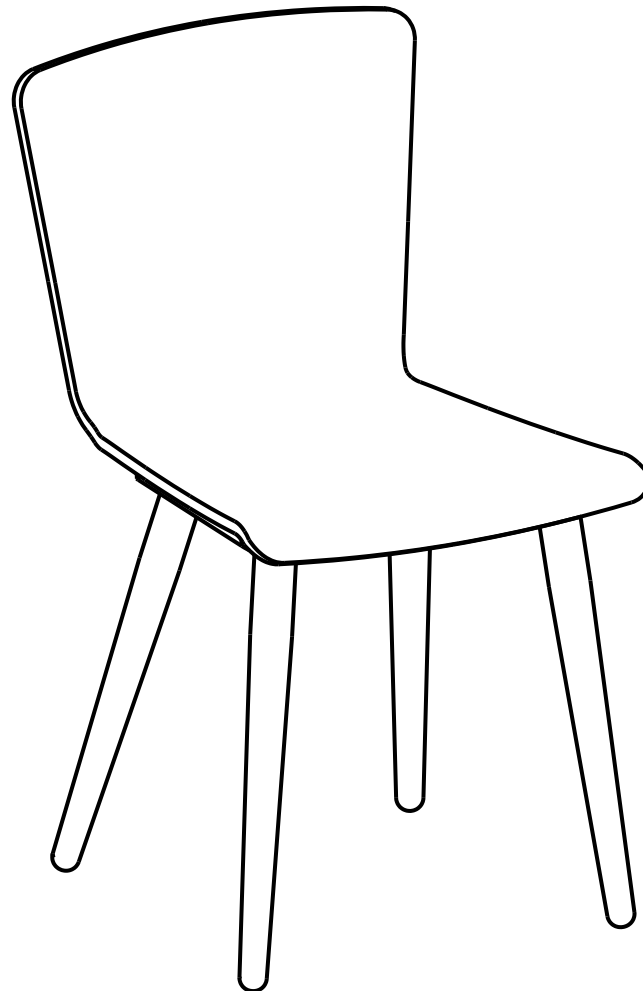

⚠ Tighten all Bolts with Allen Key (D)

**IMPORTANT !**

It is important that all bolts are re-tightened 2 weeks after assembly and once every 2 months in order to assure stability through-out the lifespan of this product.