

ARTICLE.

VERSION 1.1

Assembly Instructions

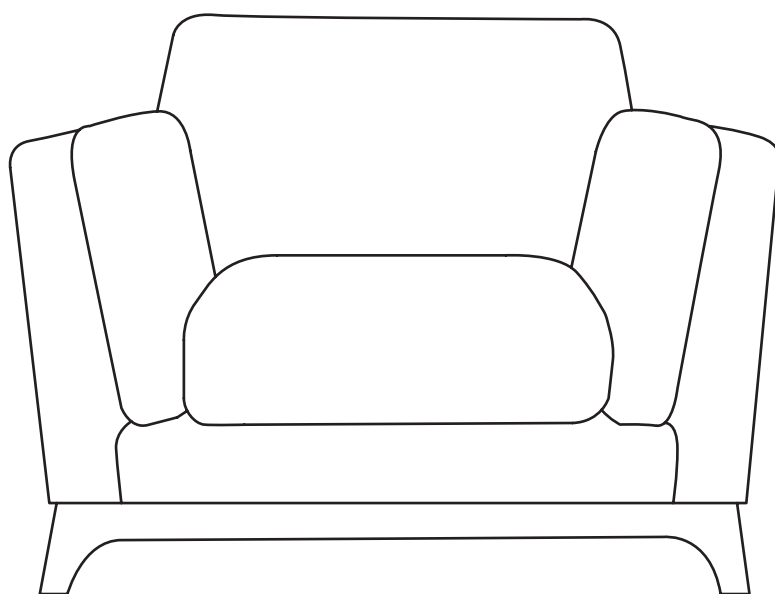

CENI

Armchair

ASSEMBLY INSTRUCTIONS

Read these instructions carefully and keep for future reference. Refer to parts inventory for guidance, and ensure you have all pieces before starting.

When assembling, place all parts on a soft, clean, and flat surface such as a carpet to prevent scratches.

If you're having difficulty, our friendly Customer Care team is always here to help. Call us at **1.888.746.3455** during business hours, email service@article.com or chat live at [article.com](https://www.article.com).

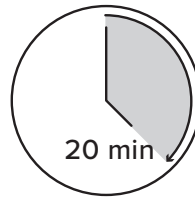

20 min

TIME

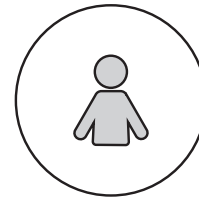



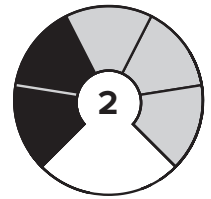





OF PEOPLE



2

DIFFICULTY

| PARTS INVENTORY | | |
|-----------------|---|-----|
| ID | DESCRIPTION | QTY |
| A | ARMCHAIR | 1 |
| B | LEG  | 4 |
| C | WASHER  | 8 |
| D | LOCK WASHER  | 8 |
| E | M8 NUT  | 8 |
| F | WRENCH  | 1 |

| PARTS INVENTORY CONT. | | |
|-----------------------|--|-----|
| ID | DESCRIPTION | QTY |
| G | BACK CUSHION  | 1 |
| H | SEAT CUSHION  | 1 |
| I | SIDE CUSHION  | 2 |

1

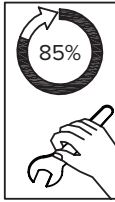

! Do not fully tighten nuts. Ensure all 4 legs are tightened by 85%.



! Once all nuts are in place, fully tighten all nuts on leg frames before turning chair upright.

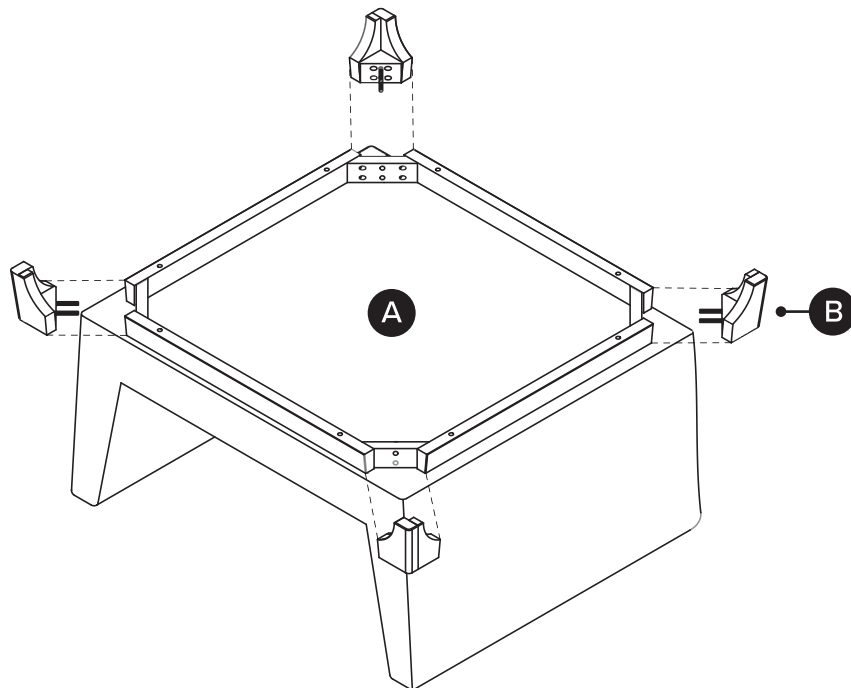
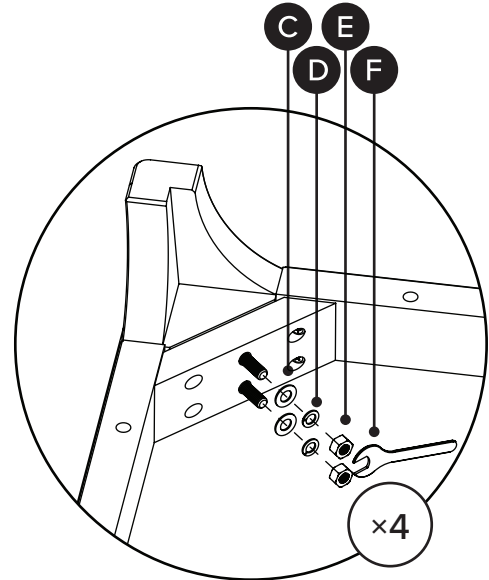

2

