

# ARTICLE.

VERSION 1.0

## Assembly Instructions

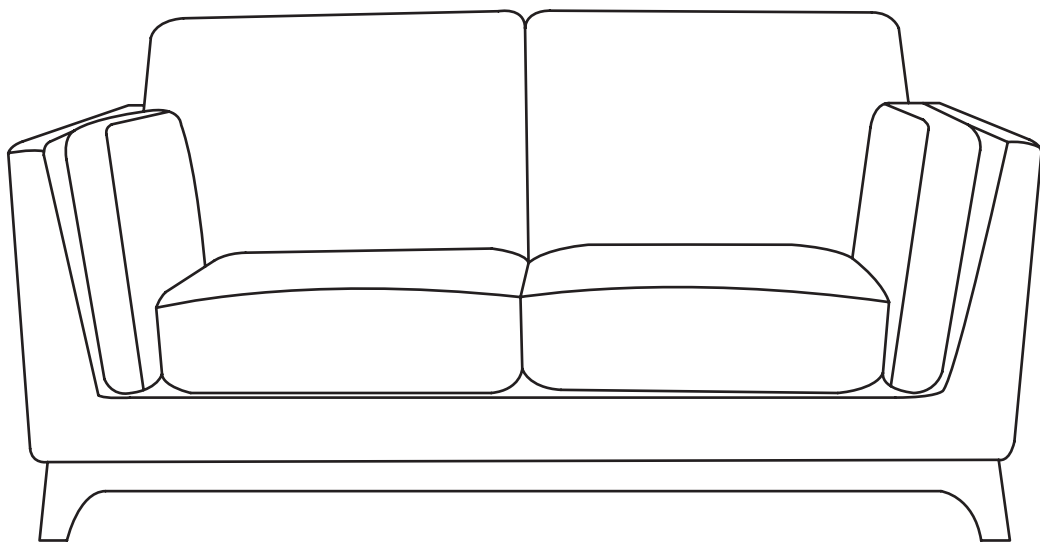

# CENI

Loveseat

## ASSEMBLY INSTRUCTIONS

Read these instructions carefully and keep for future reference. Refer to parts inventory for guidance, and ensure you have all pieces before starting.

When assembling, place all parts on a soft, clean, and flat surface such as a carpet to prevent scratches.

If you're having difficulty, our friendly Customer Care team is always here to help. Call us at **1.888.746.3455** during business hours, email [service@article.com](mailto:service@article.com) or chat live at [article.com](https://www.article.com).

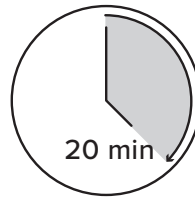



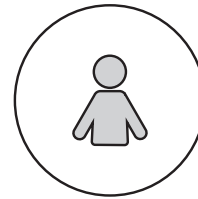

TIME





# OF PEOPLE

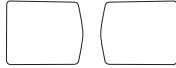

DIFFICULTY

PARTS INVENTORY		
ID	DESCRIPTION	QTY
<b>A</b>	LOVESEAT	1
<b>B</b>	LEG 	4
<b>C</b>	WASHER 	8
<b>D</b>	LOCK WASHER 	8
<b>E</b>	M8 NUT 	8
<b>F</b>	WRENCH 	1

PARTS INVENTORY CONT.		
ID	DESCRIPTION	QTY
<b>H</b>	BACK CUSHION 	2
<b>I</b>	SEAT CUSHION 	2
<b>J</b>	SIDE CUSHION 	2

1

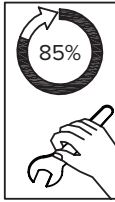

! Do not fully tighten nuts. Ensure all 4 legs are tightened by 85%.



! Once all nuts are in place, fully tighten all nuts on leg frames before turning chair upright.

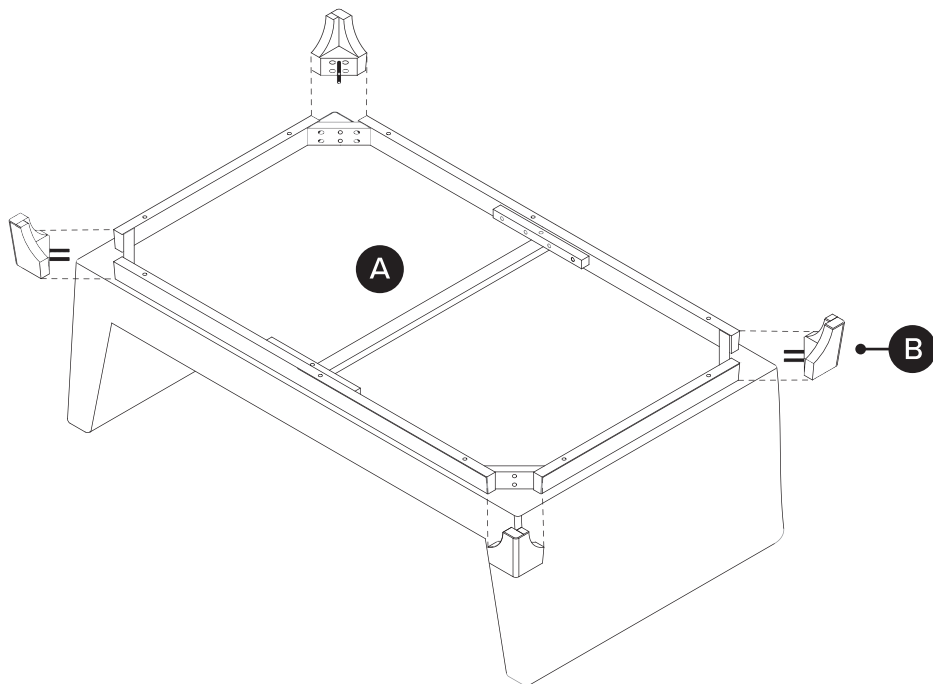
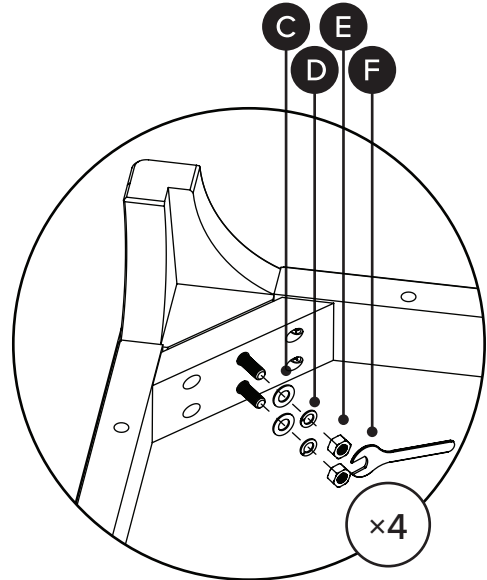

2

---

