

# ARTICLE.

VERSION 1.0

## Assembly Instructions

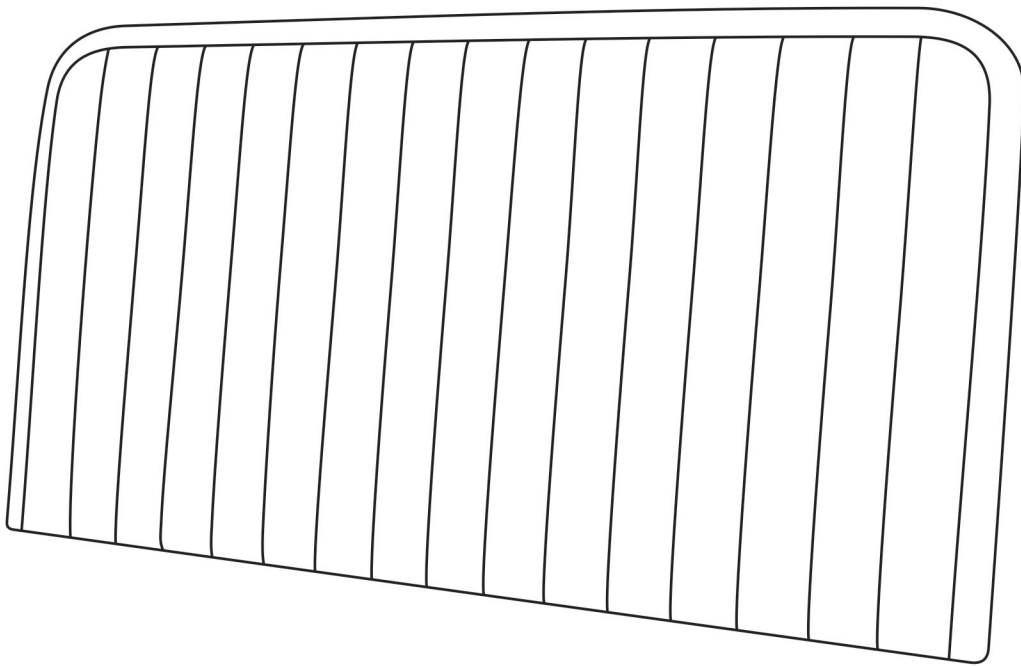

# ROLPH

Headboard Queen Size

## ASSEMBLY INSTRUCTIONS

Read these instructions carefully and keep for future reference. Refer to parts inventory for guidance, and ensure you have all pieces before starting.

When assembling, place all parts on a soft, clean, and flat surface such as a carpet to prevent scratches.

If you're having difficulty, our friendly Customer Care team is always here to help. Call us at **1.888.746.3455** during business hours, email **service@article.com** chat live at **article.com**

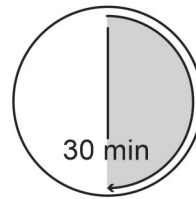

TIME



# OF PEOPLE

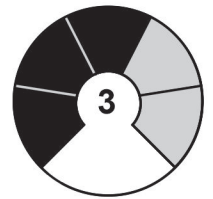

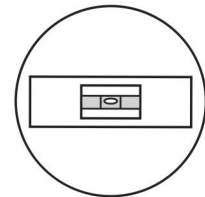
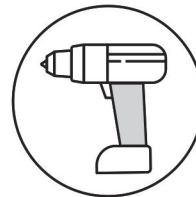

DIFFICULTY



REQUIRED TOOL

5/8" DRILL BIT

PARTS INVENTORY		
ID	DESCRIPTION	QTY
<b>A</b>	ROLPH HEADBOARD	1
<b>B</b>	WOOD CLEAT	1
<b>C</b>	BUTTERFLY NUT 	3
<b>D</b>	WASHER 	3
<b>E</b>	BOLT 	3
<b>F</b>	PAPER MEASUREMENT	1

1

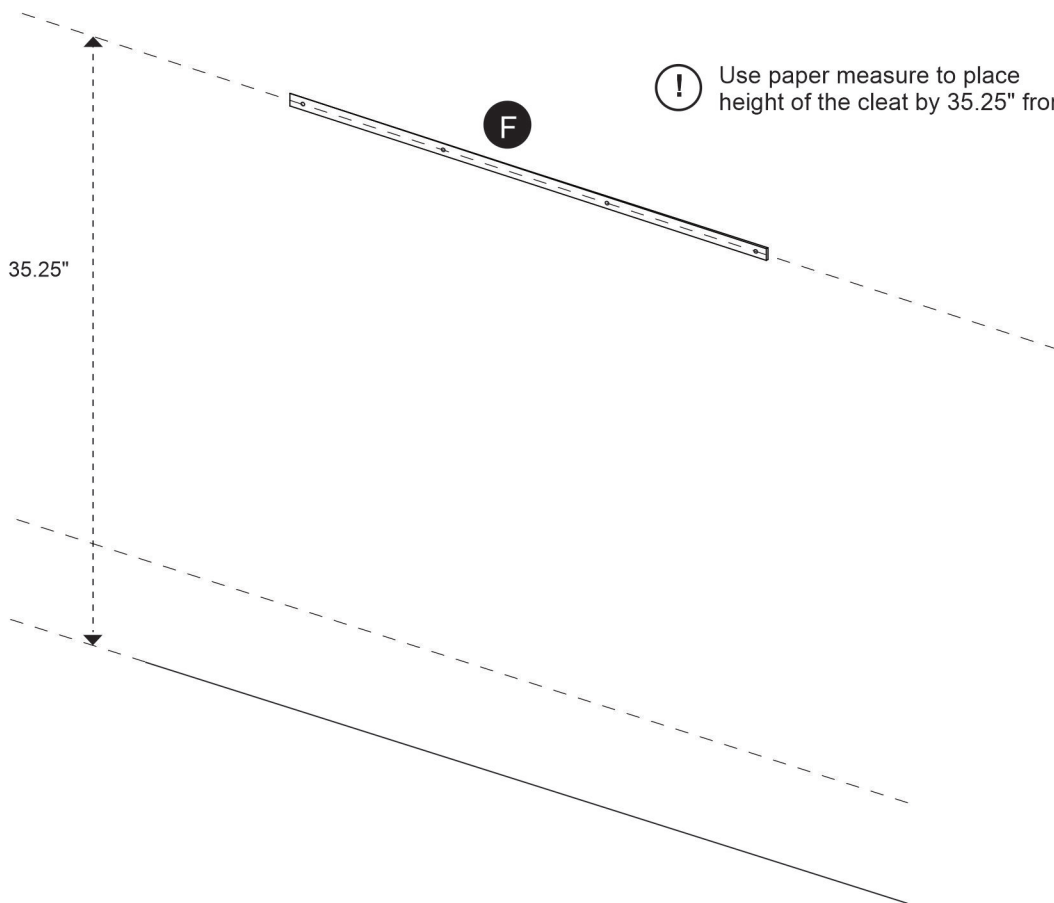

2

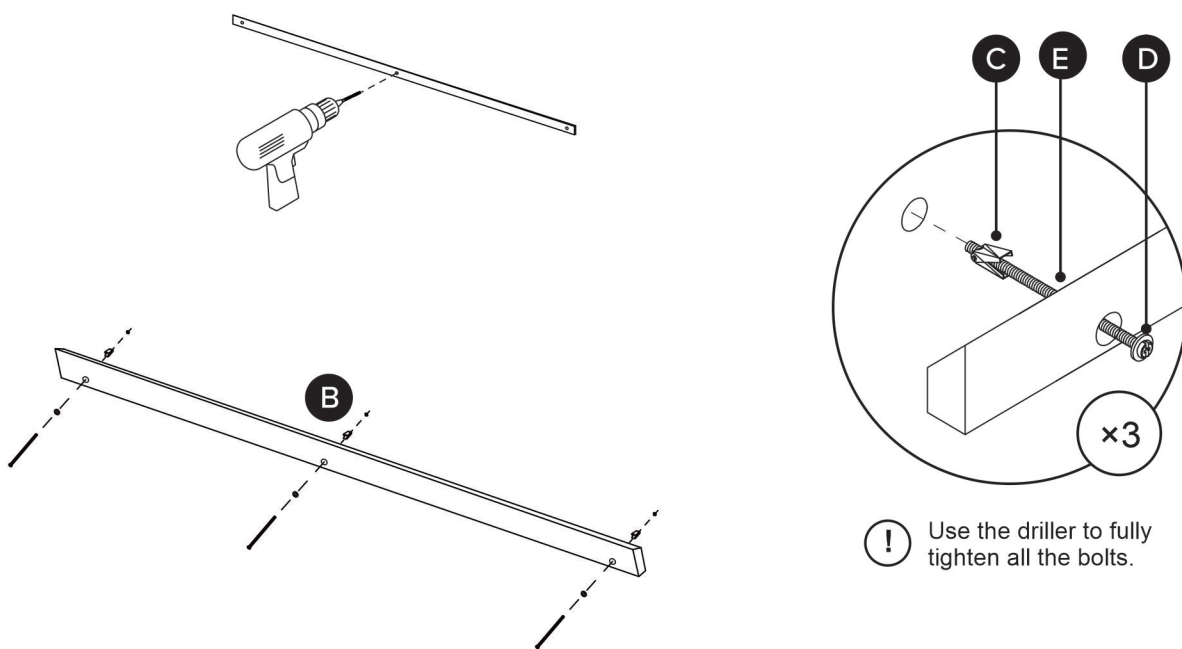

3

---

