

# ARTICLE.

VERSION 1.1

## Assembly Instructions

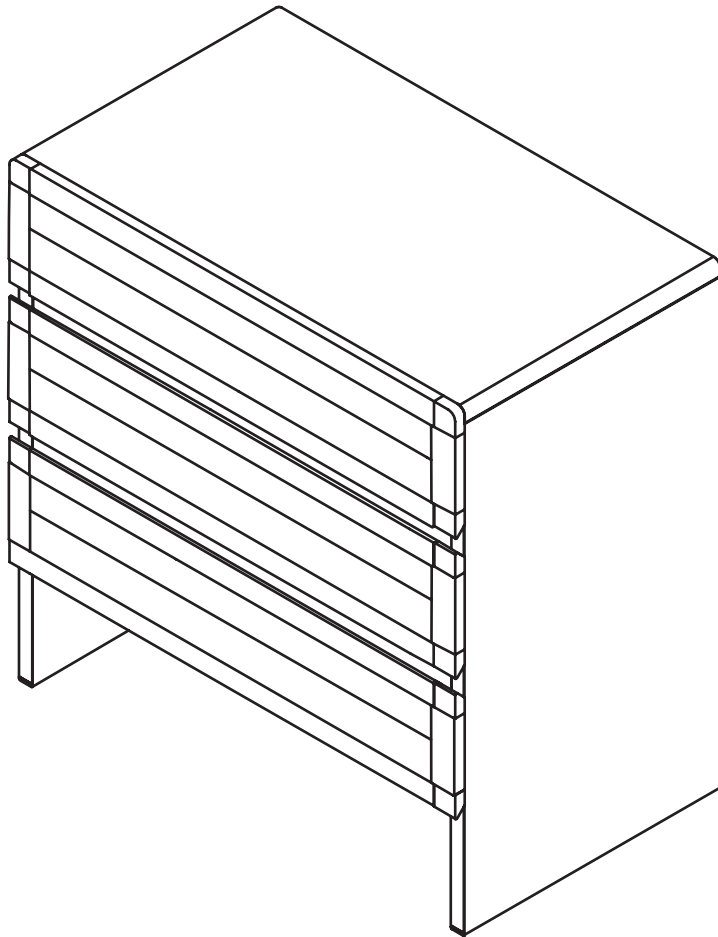

# MONTEREY

3 Drawer Chest



## ANTI-TIP RESTRAINT INSTALLATION

### WARNING!

Children have died from furniture tipover.  
To reduce the risk of furniture tipover:

- ALWAYS install tipover restraint provided.
- NEVER put a TV on this product.
- NEVER allow children to stand, climb or hang on drawers, doors, or shelves.
- NEVER open more than one drawer at a time.
- Place heaviest items in the lower drawers.



TIME

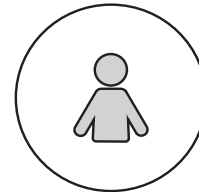

# OF PEOPLE

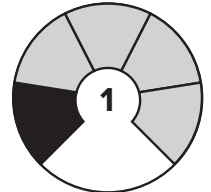



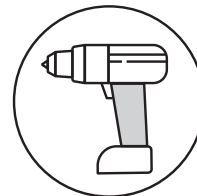

DIFFICULTY

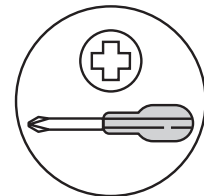

REQUIRED TOOL

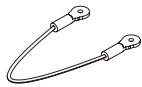

REQUIRED TOOL

PARTS INVENTORY			
ID	DESCRIPTION		QTY
<b>A</b>	M8 × 38MM SCREW		4
<b>B</b>	M8 × 15MM SCREW		4
<b>C</b>	WALL BRACKET		4
<b>D</b>	AIRCRAFT CABLE		2
<b>E</b>	CLEVIS PIN		4
<b>F</b>	HAIR CLIP		4



Hardware (B/C) to attach brackets to wall is designed for drywall. To attach this unit to another type of wall, consult with your local hardware store.

#

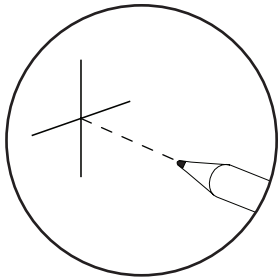

Mark on wall where brackets should be placed.

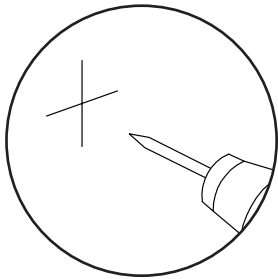

Drill hole in the wall using the drill bit.

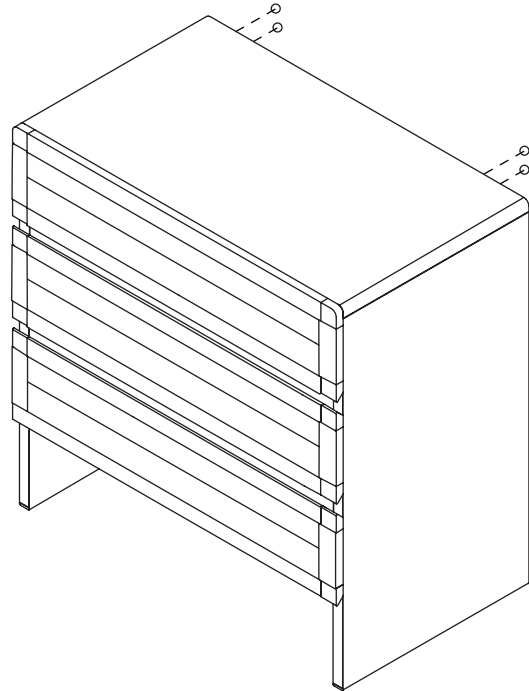

#

