

ARTICLE.

VERSION 1.1

Assembly Instructions

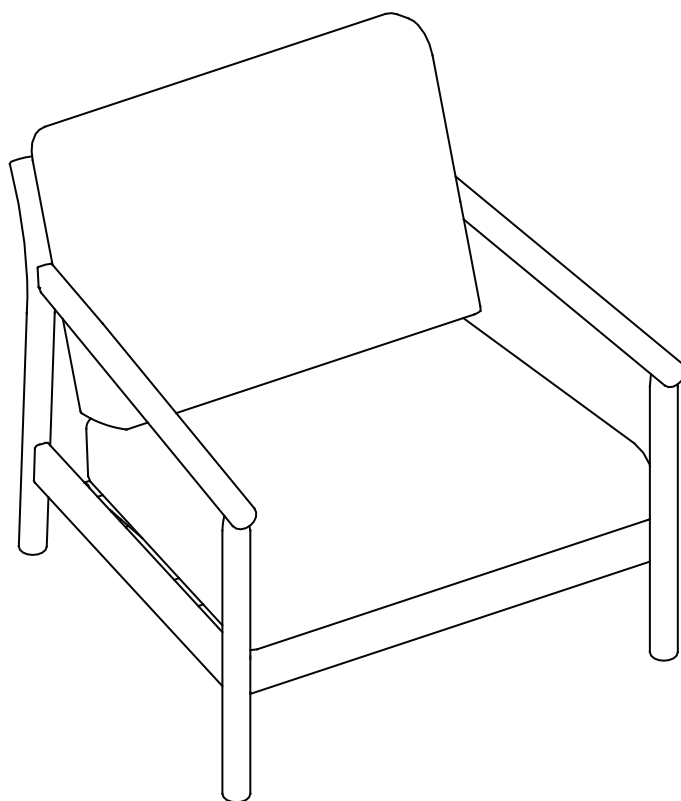

ROSA

Lounge Chair

ASSEMBLY INSTRUCTIONS

Read these instructions carefully and keep for future reference. Refer to parts inventory for guidance, and ensure you have all pieces before starting.

When assembling, place all parts on a soft, clean, and flat surface such as a carpet to prevent scratches.

If you're having difficulty, our friendly Customer Care team is always here to help. Call us at 1.888.746.3455 during business hours, email service@article.com or chat live at [article.com](https://www.article.com).

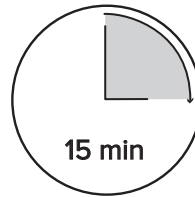

15 min

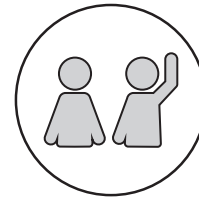

TIME

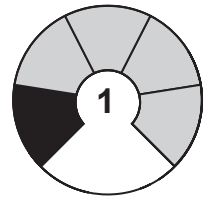

2 PEOPLE



DIFFICULTY

PARTS INVENTORY		
ID	DESCRIPTION	QTY
A	Lounge Chair 	1
B	Seat cushion 	1
C	Back cushion 	1



Hardware may loosen over time, check the bolts regularly and tighten if necessary.

1

- Turn the product upright and adjust the levelers at the bottom of the legs (if needed) to balance the rosa lounge chair.

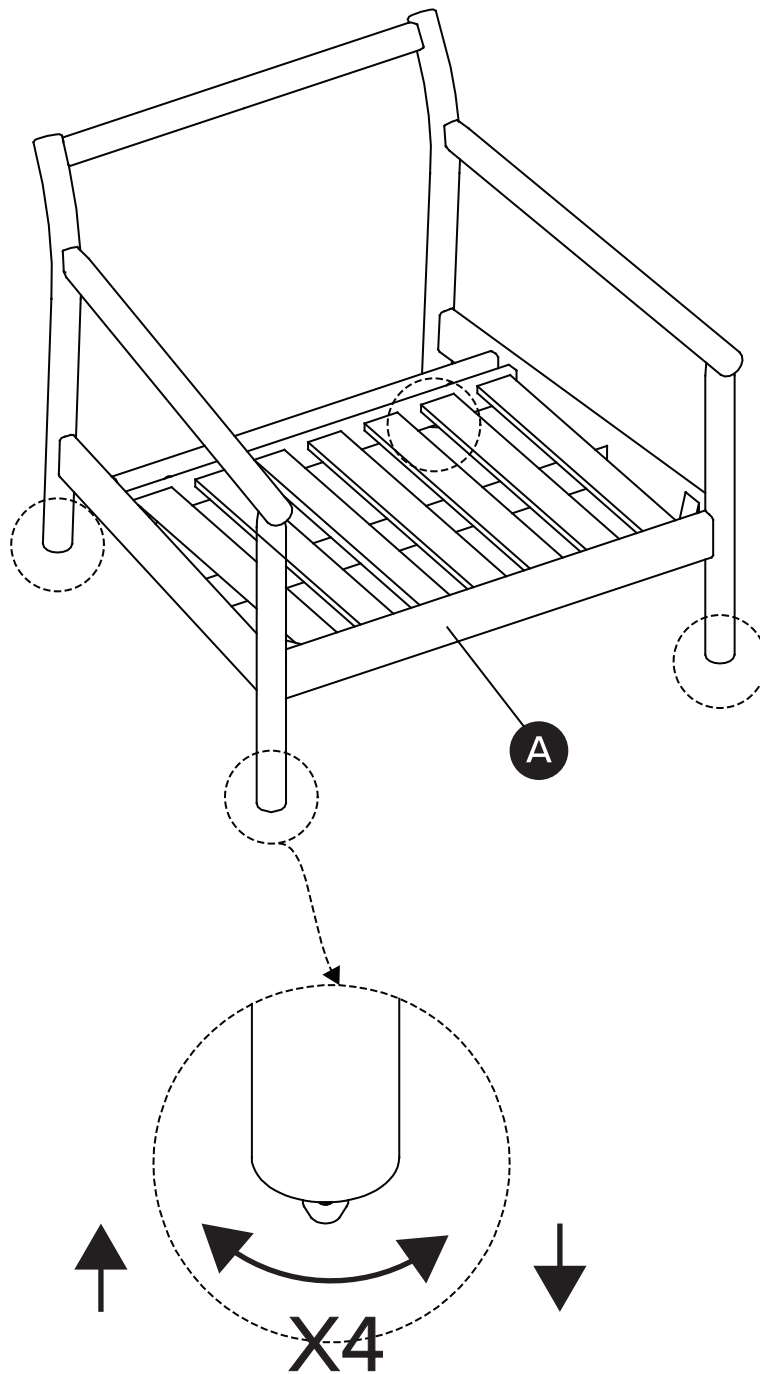

2

- Insert seat cushion (B) first, then insert back cushion (C) after.

