

ARTICLE.

Assembly Instructions

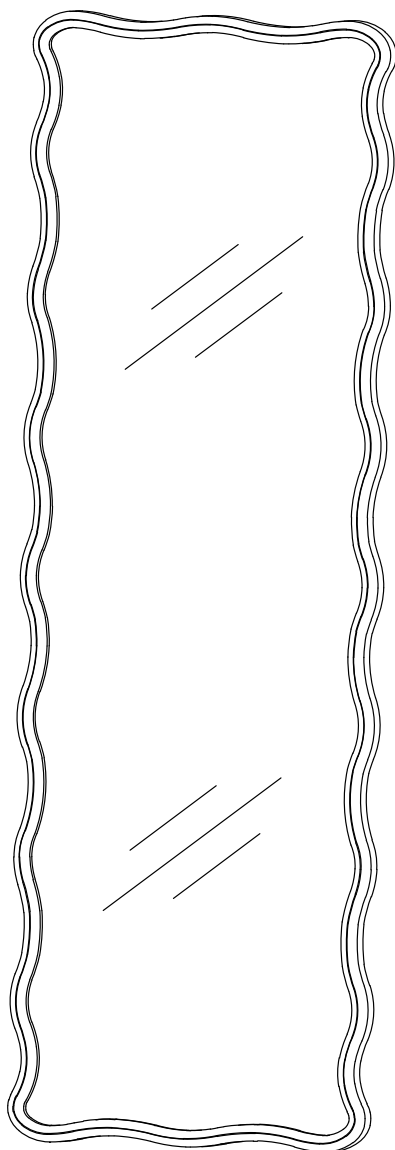

ALMA

Floor Mirror

ASSEMBLY INSTRUCTIONS

Read these instructions carefully and keep for future reference. Refer to parts inventory for guidance, and ensure you have all pieces before starting.

When assembling, place all parts on a soft, clean, and flat surface such as a carpet to prevent scratches.

If you're having difficulty, our friendly Customer Care team is always here to help. Call us at **1.888.746.3455** during business hours, email service@article.com or chat live at article.com.

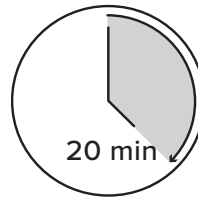

20 min

TIME



OF PEOPLE

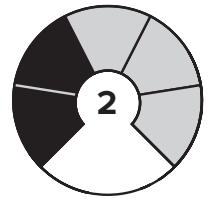



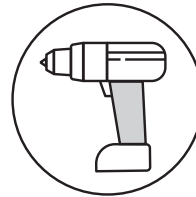

DIFFICULTY

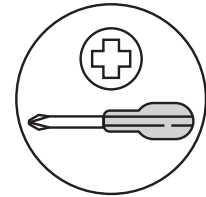

REQUIRED TOOL
8MM / 5/16" DRILL BIT



REQUIRED TOOL

PARTS INVENTORY		
ID	DESCRIPTION	QTY
A	PLASTIC WALL ANCHOR 	4+1
B	M5 × 40MM SCREW 	4+1
C	FURNITURE BRACKET 	4
D	FURNITURE STRAP 	2
E	M4 × 12MM BOLT 	4



Hardware (A/B/C) to attach brackets to wall is designed for drywall. To attach this unit to another type of wall, consult with your local hardware store.

1

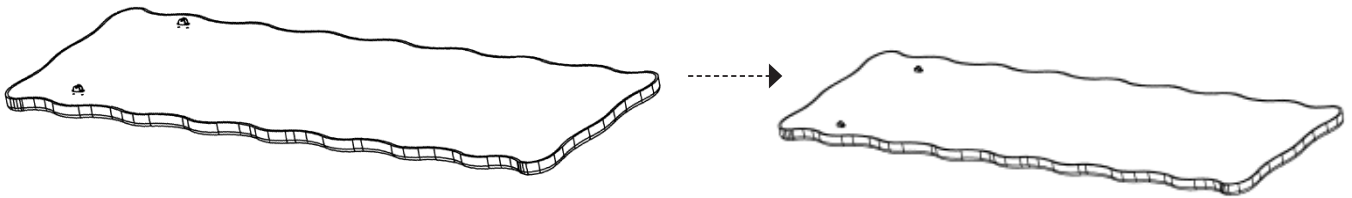
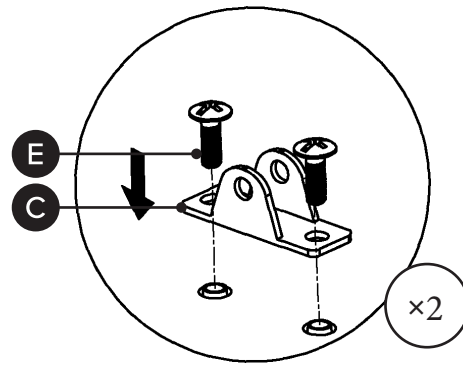

2

Drill holes in wall using
8mm / 5/16" drill bit.

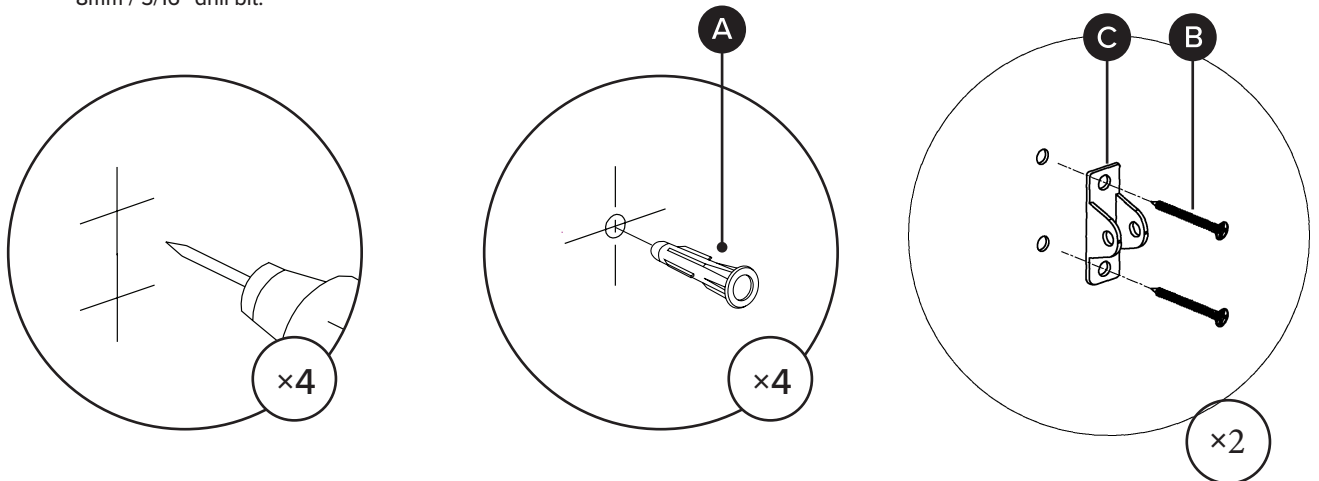

3

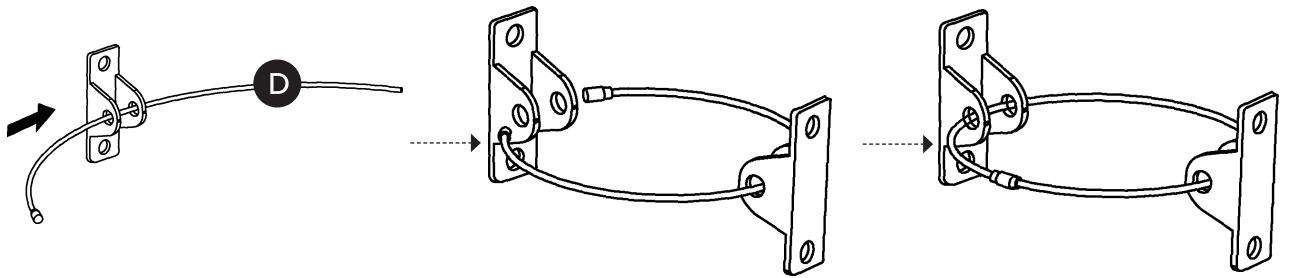

4

! Put the mirror against the wall.

