

ARTICLE.

VERSION 1.0

Assembly Instructions

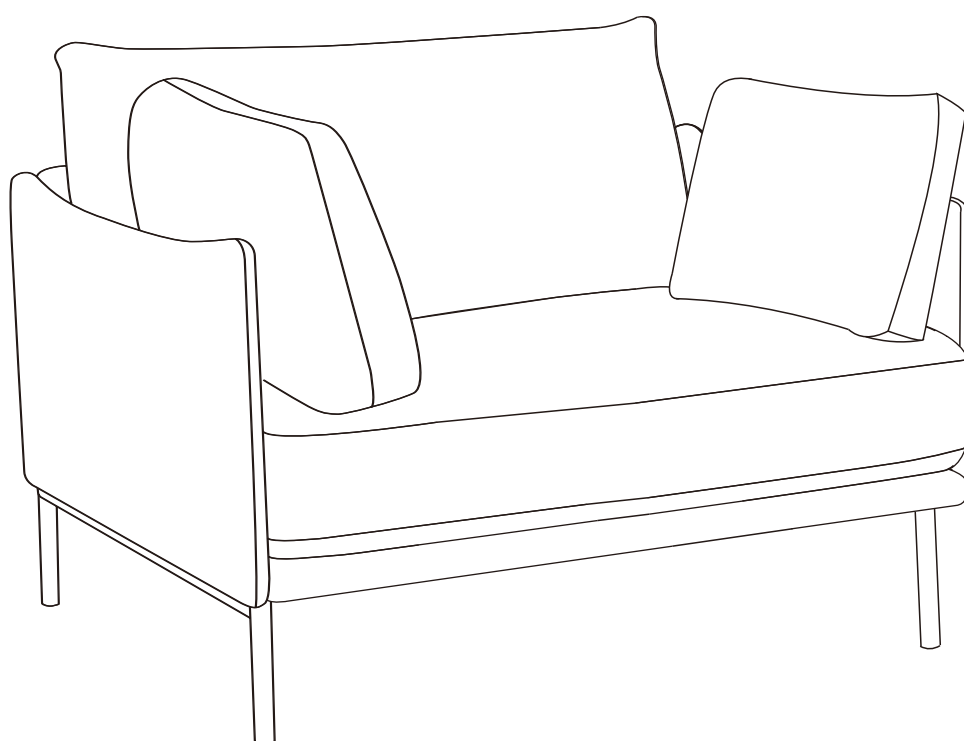

OLSEN

40" Lounge Chair

ASSEMBLY INSTRUCTIONS

Read these instructions carefully and keep for future reference. Refer to parts inventory for guidance, and ensure you have all pieces before starting.

When assembling, place all parts on a soft, clean, and flat surface such as a carpet to prevent scratches.

If you're having difficulty, our friendly Customer Care team is always here to help. Call us at 1.888.746.3455 during business hours, email service@article.com or chat live at [article.com](https://www.article.com).

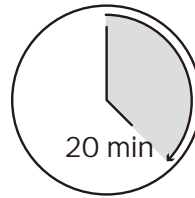

TIME

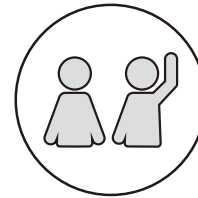



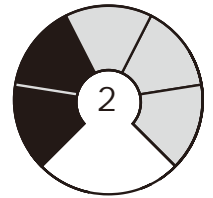

OF PEOPLE

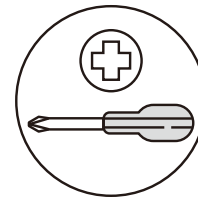

DIFFICULTY



REQUIRED TOOL

PARTS INVENTORY		
ID	DESCRIPTION	QTY
A	LOUNGE CHAIR	1
B	METAL LEG BAR 	2
C	LARGE ALLEN KEY 	1
D	M10 x25MM BOLT 	4
E	M5x40MM SCREW 	4

1

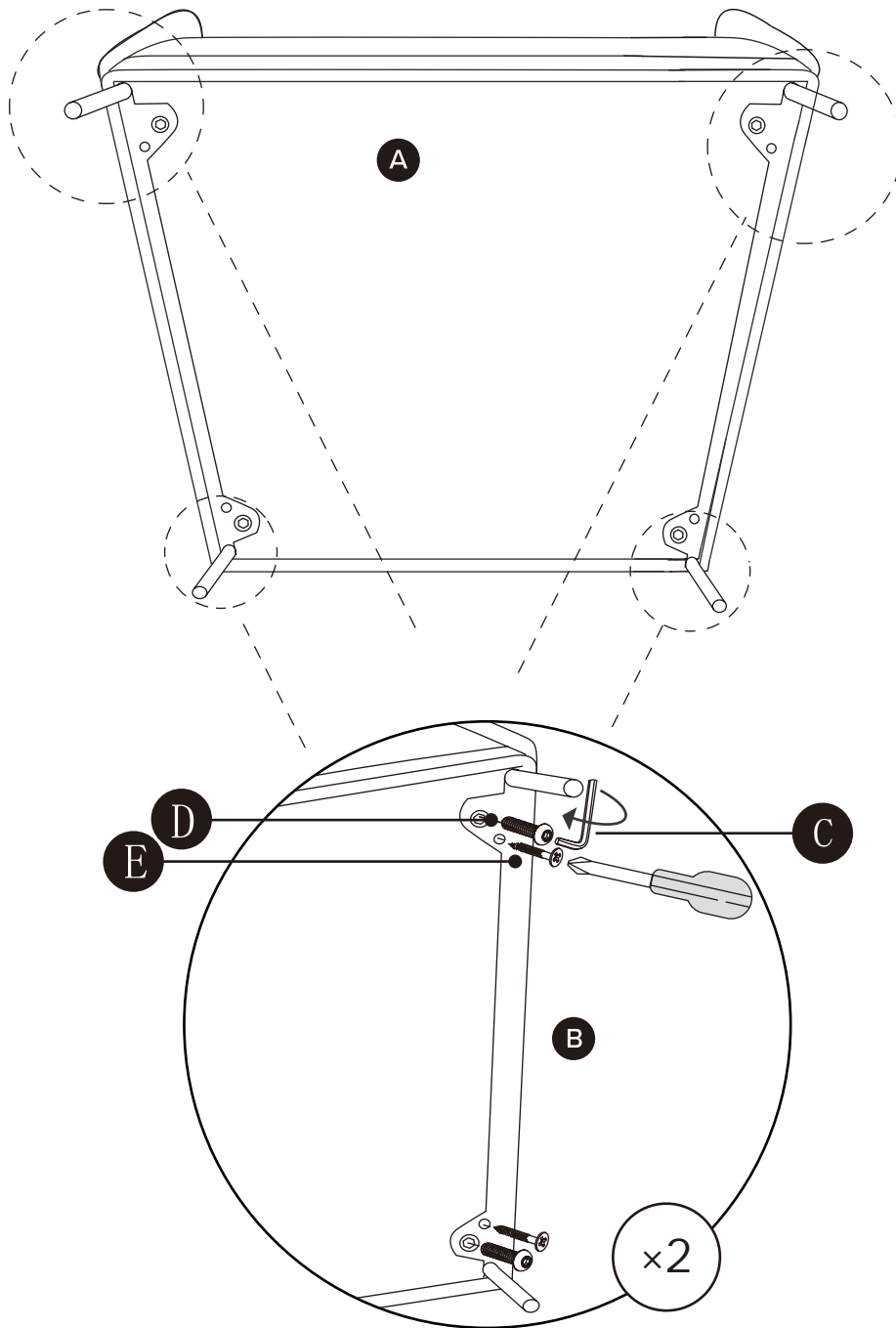

2

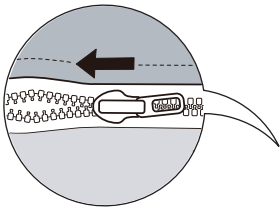

! Attach the zipper on the back cushion to the zipper on the back frame.

