

ARTICLE.

VERSION 1.0

Assembly Instructions

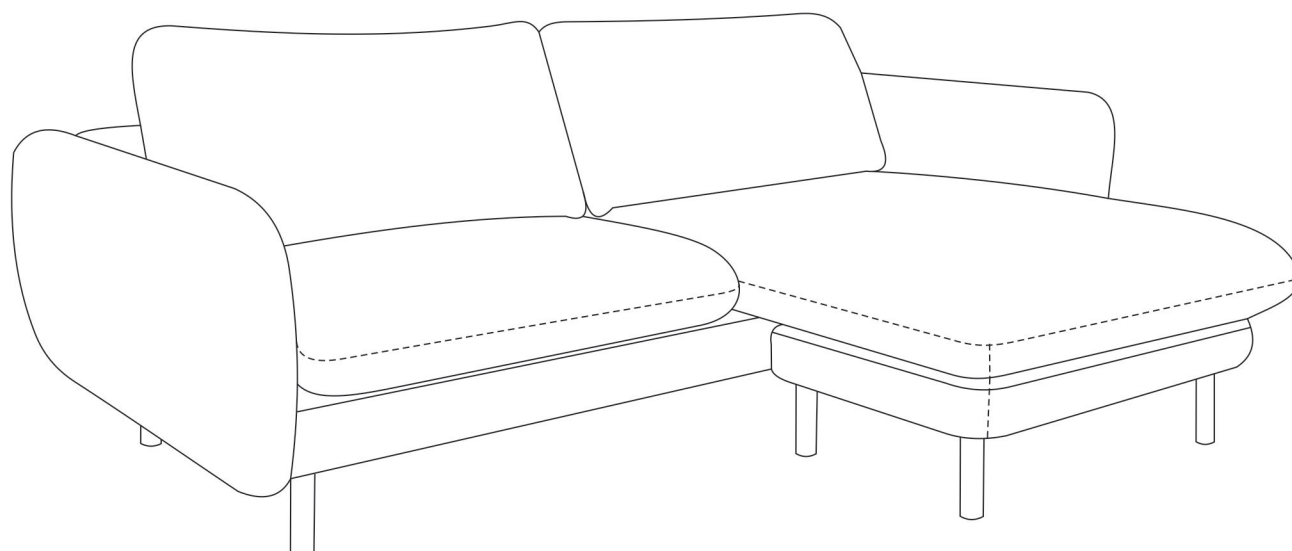

SANDERS

Reversible Sectional

ASSEMBLY INSTRUCTIONS

Read these instructions carefully and keep for future reference. Refer to parts inventory for guidance, and ensure you have all pieces before starting.

When assembling, place all parts on a soft, clean, and flat surface such as a carpet to prevent scratches.

If you're having difficulty, our friendly Customer Care team is always here to help. Call us at **1.888.746.3455** during business hours, email **service@article.com** chat live at **article.com**

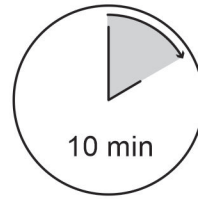

10 min

TIME

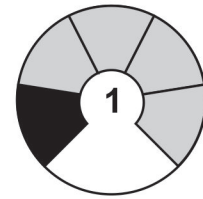

1





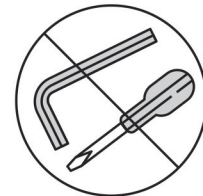

DIFFICULTY

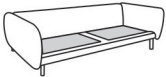

OF PEOPLE

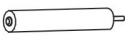

TOOL FREE

PARTS INVENTORY		
ID	DESCRIPTION	QTY
A	Sofa A 	1
B	Sofa B 	1
C	Corner Seat Cushion 	1
D	Seat Cushion 	1
E	Back Cushion 	2
F	Corner Leg 	8
G	Center Leg 	2
H	PLASTIC WASHER 	10

1A

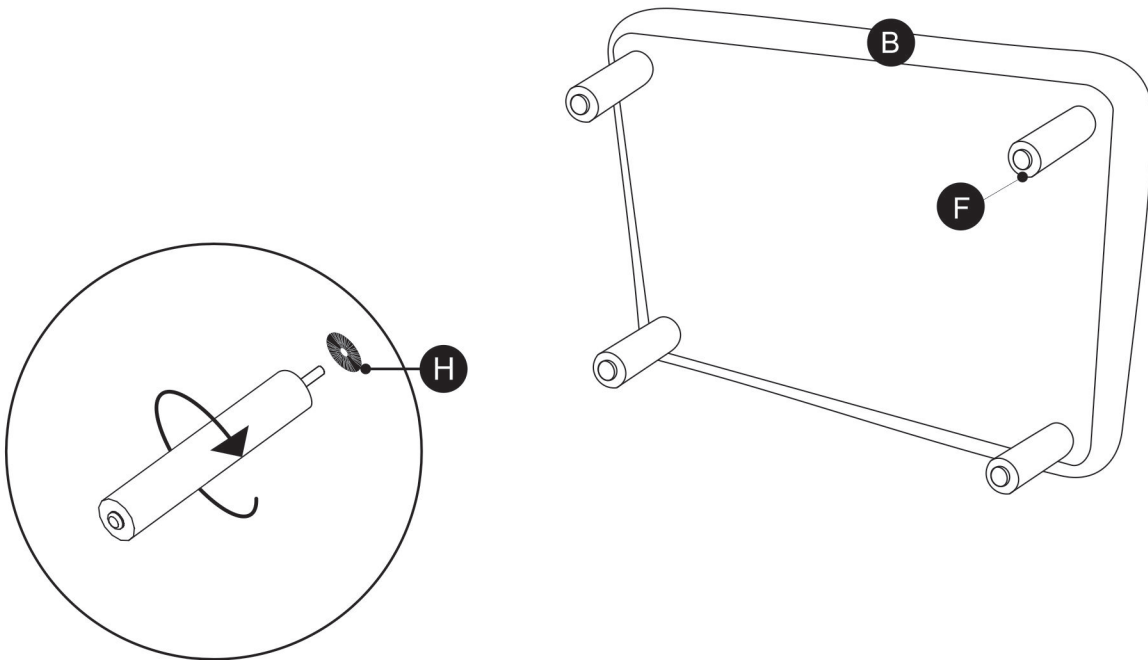

1B

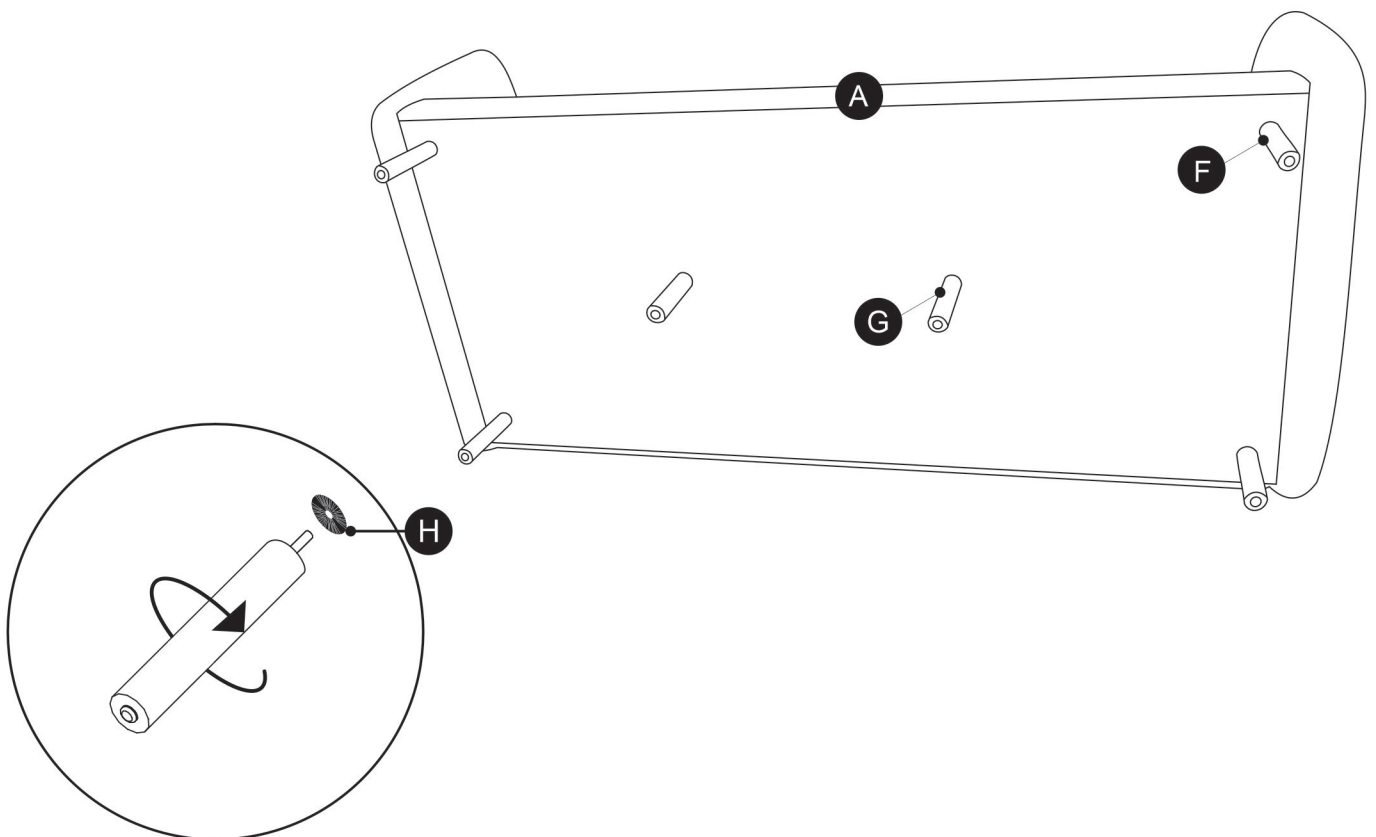

2A Right Sectional Sofa

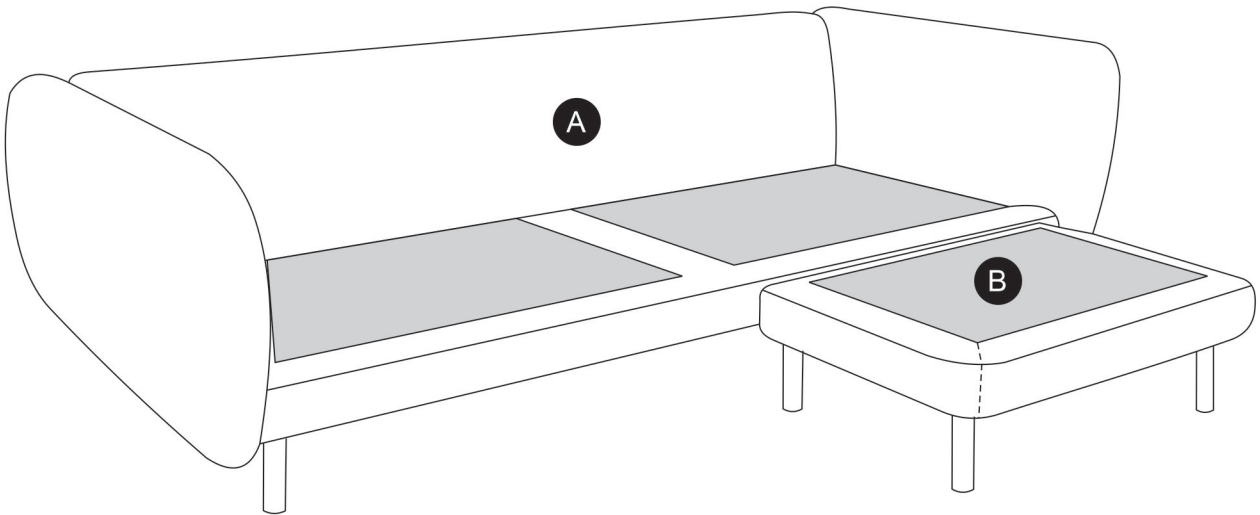

2B

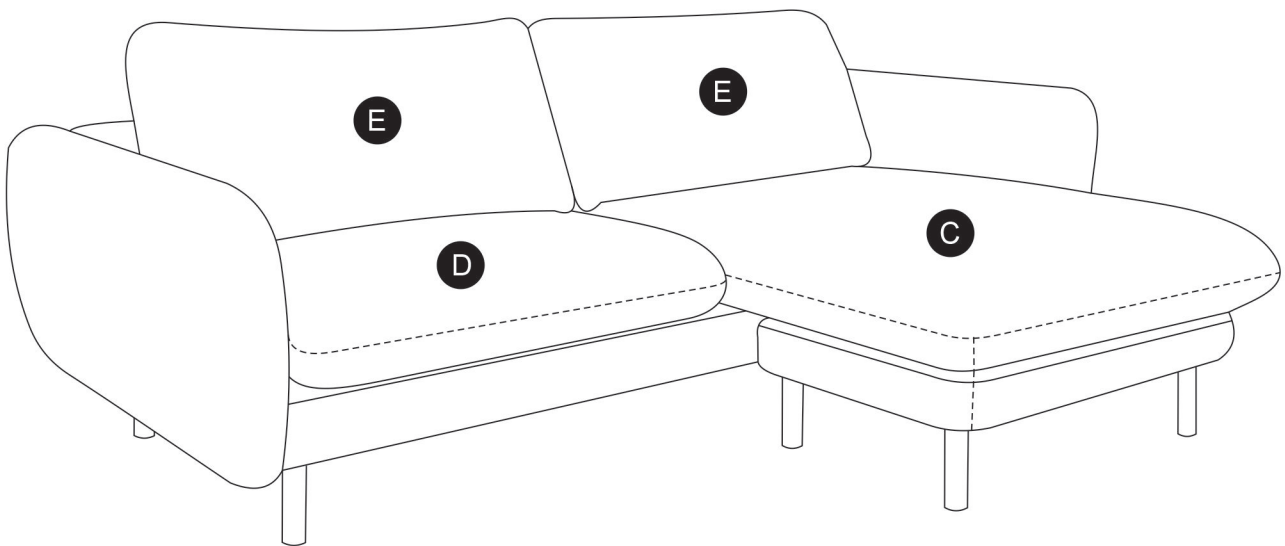

3A Left Sectional Sofa

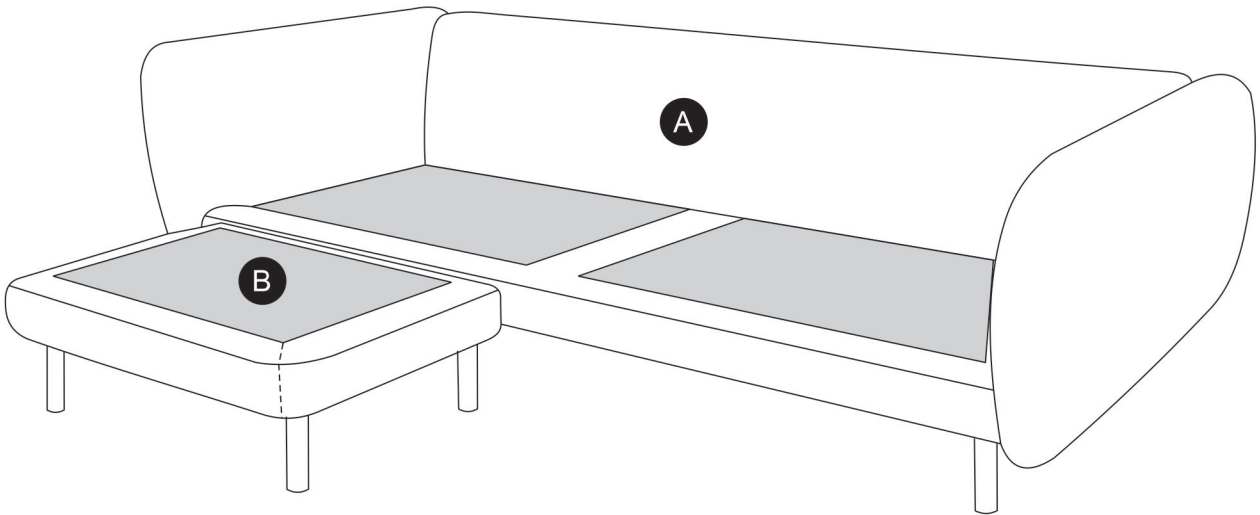

3B

